



# PRODUCT CATALOG

[sealmaster.net](http://sealmaster.net)

# TABLE OF CONTENTS

	<b>PAVEMENT SEALERS</b> MasterSeal, PMM, Liquid Road, AsPen, OptiPave, SealMaster E-Z Stir, Coal Tar Pavement Sealer, PMCTS, ColorPave, ColorPave HD, Safe Ride . . . . .	5-16
	<b>SEALER ADDITIVES</b> Top Tuff, PaveGel, Zetac, FASS-DRI, FSA, FSA AE . . . . .	17-20
	<b>CRACK FILLERS</b> CrackMaster Hot Pour Crack Sealants . . . . . TruFlex, FlexMaster, Pourable Crack Sealant, LoopMaster, GatorPave, Trowel Grade, Acrylic Crack Filler . . . . .	21-23 24-27
	<b>PREPARATION / REPAIR</b> AquaSet, PatchMaster Pothole Patch, Asphalt Binder, Asphalt Binder Plus, Oil Spot Primers, TarBuster Cleaner, Tarpedo, MasterFlo . . . . .	28-33
	<b>TRAFFIC PAINTS</b> Velocity, Liquid Thermoplastic, Acrylic Traffic Paint, Line Block-Out, Handicap Blue, TTP-1952b Traffic Paint, Fast Dry Traffic Paint, Firelane Red, Acrylic Low VOC Traffic Paint, GameTime . . . . .	34-39
	<b>CONCRETE PRODUCTS</b> Concrete Sealer, Concrete Patch Binder, Concrete Repair Materials . . . . .	40-41
	<b>DUST SUPPRESSANT</b> Dust Suppressant and Soil Stabilizer . . . . .	42-43
	<b>EQUIPMENT</b> SP 300 Squeegee Machine, SP 300 Dual Spray/Squeegee Machine . . . . . SP 575 Squeegee Machine, SP 575 Dual Squeegee Machine . . . . . SprayMaster Tank Trailers, SprayMaster Skid Tanks, SprayMaster Tanks - Truck Mounts . . . . . SandPup Trailers & Skid Unit, SandPup Portable Pumps, Crack Pro Cold-Pour Crack Filler Application Units . . . . . Texture Spray Unit, Porta-Pump, Sealer Wheeler . . . . . Heated Asphalt Storage Tanks, Bulk Storage Tanks, Hand-Agitated Mixing Tanks . . . . . Aggregate Chip Spreader . . . . . Heated Asphalt Distributors . . . . . MA-10 Melter Applicator, SM-10 Melter, Crack Pro Turbo, Hot Air Lance, SM-30 Melter . . . . . Crack Pro Direct Fire Melter, Crack Pro Gravity Flow, Heated Hose Machines . . . . . Crack Pro Melter/Applicator Options . . . . . Blowers, Crack Cleaners, Rotary Brooms . . . . . Striping Machines . . . . .	45-46 47-48 49-53 54-56 57 58-60 61 62-63 64-65 66-69 70 72-73 74-77
	<b>PARTS</b> . . . . .	82
	<b>TOOLS / ACCESSORIES</b> Traffic & Athletic Field Marking Systems . . . . . Squeegees, Brushes, Brooms . . . . . Spray Tips, Crack Filling Tools . . . . . Lutes, Rakes, Shovels, Hand Tamper . . . . . Chapin Sprayer, Scraper, Asphalt Shoes, Pail Openers . . . . . Measuring Wheels, Fast Measure Distance Device, Traffic Control Signs, Safety Signs, Sign Base . . . . . Parking Blocks, Speed Bumps . . . . . Ideal Shield Post Sleeves . . . . . Traffic Cones, Caution Tape, Coveralls, Striping Layout Tools, Personal Protection and Care Products . . . . . Stencils . . . . .	84-85 86-87 88-89 90 91 92-93 94 95 96 97-100
	<b>SPORT SURFACING</b> ColorPlus Color Coating System, Flexible Concentrate . . . . . ProCushion System Coatings . . . . . SportMaster System Color Coatings . . . . . Resurfacers . . . . . Patching and Crack Filling Materials . . . . . Striping Paints, Acrylic Adhesion Promoter, SportWax Clear Coat . . . . . SkateMaster In-Line Skate Surface System . . . . . TrackMaster Running Track Coating, Sealing and Repair Materials, Black Dispersion . . . . . Tennis Court Accessories - Nets, Windscreens, Posts, etc . . . . . Power Washer, Straightedge, Squeegee . . . . . Tools, Basketball Goal Systems . . . . . Color Coating Mixing Tanks . . . . .	102-103 104-105 106-107 108 109 110 111 112-113 114-115 116 117 118
	<b>PROMOTIONAL LITERATURE, &amp; CLOTHING</b> . . . . .	119-123

# The Road to Success Begins with SealMaster®



A SealMaster® franchise enables you to manufacture SealMaster Pavement Sealers and distribute a full line of pavement maintenance products and equipment into the billion dollar pavement maintenance industry.

*"The SealMaster franchise is not only a nice income generator, it's a great capital asset and wealth builder. The SealMaster franchise has been the best investment in my life. It has allowed me a lifestyle beyond my hopes and dreams."*

-Bob Krebs, SealMaster Franchise Owner

*"Operating my SealMaster franchise, my net worth and income have grown heartily and consistently, in spite of the worst downturn in the economy I've ever experienced."*

-Mike Bashir, SealMaster Franchise Owner



## SealMaster® Franchise Quick Facts

Typical Investment - \$650,000 to \$950,000

- Recession-Resistant Franchise
- #1 Ranked Franchise in Category by Entrepreneur Magazine
- SBA Approved for Easier Financing
- Industry Experience not Required - Training/Ongoing Support Provided

**SealMaster®**  
  
Pavement Products & Equipment  
**FRANCHISE OPPORTUNITY**



Learn more at [sealmasterfranchise.com](http://sealmasterfranchise.com) or call (800) 341-7325

# Discover Why SealMaster® is a Worldwide Leader in the Pavement Maintenance Industry...

## SealMaster...

SealMaster is driven by a philosophy of total dedication to the pavement maintenance industry. Quality products, competitive pricing, outstanding service and a strong commitment to research and development are the reasons why SealMaster continues to be an industry leader.

## Quality Products...

A complete line of pavement products, sport surfacing materials, and equipment available for pick up or delivery at SealMaster stores nationwide.

## Outstanding Service...

Each SealMaster store is staffed by personnel trained to provide technical support. Our specialized transportation fleet enables us to provide convenient delivery of the diverse SealMaster product line.



Copyright © 2019 by InFrasys, Inc. All rights reserved. Reproduction of any of this catalog and its accompanying materials is strictly prohibited without the written permission of InFrasys, Inc. Prices in this catalog are subject to change without notice.

SealMaster, SealMaster Professional Grade, ASPen, ColorPave, ColorPave HD, CrackPro, SportMaster, Liquid Road, FlexMaster and CrackMaster are registered trademarks of ThorWorks Industries, Inc. and are licensed to InFrasys, Inc. for use in the SealMaster System. The following trade names are also owned and licensed to the SealMaster System by ThorWorks Industries, Inc.: MasterSeal, OptiPave, Top Tuff, Liquid Thermoplastic, PaveGel, Zetac, Petro Seal, Prep Seal, ColorPlus, GatorPave, PatchMaster, SkateMaster, SandPup, LevelMaster, Cushion-Master, CourtFlex, Crack Magic, Stripe Rite, TrackMaster, TrackMaster Plus, Lane One, TrackFlex, MasterFlo, Porta Pumps, MasterMix, SM-30, SprayMaster, and SportWax.

#### CREDIT TERMS & CONDITIONS

Credit terms are net 30 days (unless otherwise indicated). Any amount remaining unpaid after such date will incur a service charge of 1.5% (monthly) on the unpaid balance, until paid in full, plus any and all collection costs and attorney fees incurred to collect unpaid balances.

#### RETURNED MATERIAL POLICY

We will normally accept returned material under the following conditions: 1.) Prior written authorization from SealMaster is obtained. 2.) A copy of the invoice is furnished. 3.) The material is returned within 60 days from date of invoice. 4.) The material is in new resaleable condition. 5.) The material is normal stock for us (not a special or custom order). 6.) A 15% restocking fee plus applicable freight will be imposed on all returns. Returned material, like all other purchased material, should be paid for when due.

# SealMaster®

## ULTRA PAVEMENT SEALERS

# This Changes Everything!

**DOUBLE**  
YOUR PRODUCTION BY CUTTING  
YOUR SEALCOATING TIME IN HALF



### ULTRA ADVANTAGES

- Spend time on the jobsite “Applying Sealer” rather than “Mixing Sealer”
- Avoid injuries from lifting heavy sand bags
- Ultra is a better sealer - Higher solids and Faster drying

Finally, a pavement sealer that is truly **“READY TO APPLY.”**

No need to add sand, water or additives.

Everything is factory blended for consistency and optimum performance.

## PAVEMENT SEALERS



FORMULATED TO PROTECT & BEAUTIFY ASPHALT PAVEMENT

ASK ABOUT  
**MASTERSEAL  
ULTRA**  
FACTORY BLENDED  
WITH WATER,  
POLYMER ADDITIVE  
AND SAND



## MASTERSEAL™ ASPHALT BASED PAVEMENT SEALER

THE SMART CHOICE FOR PAVEMENT MAINTENANCE

**Advantages:**

- User friendly - no irritating fumes
- Deep, rich black color
- More flexible - won't check crack

**MasterSeal Uses:**

- Parking Lots
- Driveways
- Low-Traffic Roads
- Low-Speed Roads
- Airports
- Shopping Malls
- Highway Shoulders

**MIXING PROCEDURES:**

*(Based on 100 gallons of MasterSeal Concentrate)*

MasterSeal Concentrate.....	100 gallons
Water .....	15 - 25 gallons
Top Tuff Polymer Additive.....	1/2 - 2 gallons
Sand (40-70 mesh AFS).....	200-500 lbs.

**NOTE:** Mix thoroughly in agitated tank and apply by squeegee, brush or spray.

**MATERIAL REQUIREMENTS:** One gallon of MasterSeal Concentrate will cover approximately 100 - 120 square feet (11.1 to 13.3 square yards) per coat when properly mixed and applied.

**NOTE:** Coverage rate may vary due to pavement age, porosity, and method of application.

**UNSEALED VS. SEALED**

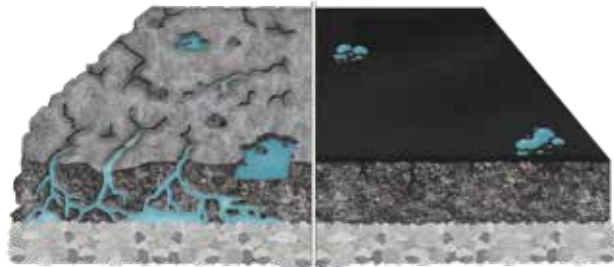

MasterSeal replenishes the binder that is lost through weathering and aging and provides a barrier to moisture intrusion as well as ultraviolet rays, chemicals and salt. MasterSeal beautifies pavement, enhancing the image and curb appeal of commercial properties, home driveways, roadways and more.

PRODUCT #	DESCRIPTION	WEIGHT	PRICE
S1010P	5 - Gallon Pail	52 lbs.	\$ 35.99
S1010D	55 - Gallon Drum	580 lbs.	\$ 334.99
S1010B	Bulk	-	- quoted -



ASK ABOUT  
**PMM**  
**ULTRA**  
 FACTORY BLENDED  
 WITH SAND ADDED



THE INDUSTRY'S #1 CHOICE FOR  
 QUALITY & PERFORMANCE

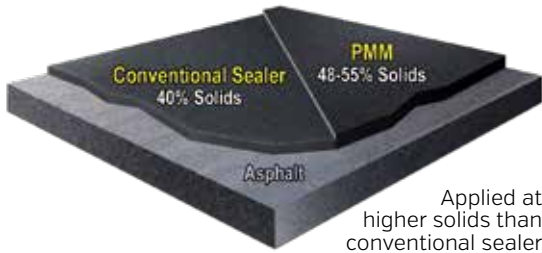

Applied at higher solids than conventional sealer

**Blended with polymers for superior adhesion, flexibility, and durability**

**Polymer-Modified MasterSeal Uses:**

- Parking Lots
- Driveways
- Low-Traffic Roads
- Low-Speed Roads
- Airports
- Shopping Malls
- Highway Shoulders

**MIXING PROCEDURES:**

*[Based on 100 gallons of Polymer-Modified MasterSeal]*

- PMM ..... 100 gallons
- Sand [40-70 mesh AFS].....200-400 lbs.

**NOTE:** If required, a small amount of water may be added to facilitate application of mixed material.

**MATERIAL REQUIREMENTS:** One gallon of PMM will cover approximately 85 - 95 square feet [9.4 to 10.5 square yards] per coat when properly mixed as a sand-filled coat and applied.

**NOTE:** Coverage rate may vary due to pavement age, porosity, and method of application.

**POLYMER-MODIFIED MASTERSEAL™ (PMM)**

ASPHALT BASED PAVEMENT SEALER

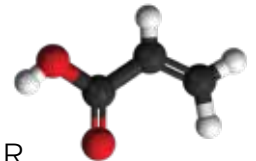

**POLYMER MODIFIED FOR MAXIMUM DURABILITY**

**Advantages:**

- Added strength, adhesion, flexibility, fuel resistance, and UV resistance
- Deep, rich black color

**UNSEALED VS. SEALED**

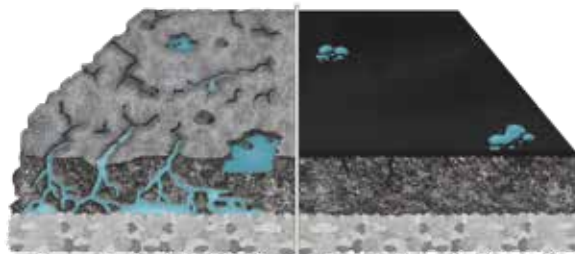

PMM replenishes the binder that is lost through weathering and aging and provides a barrier to moisture intrusion as well as ultraviolet rays, chemicals and salt. PMM beautifies pavement, enhancing the image and curb appeal of commercial properties, home driveways, roadways and more.

PRODUCT #	DESCRIPTION	WEIGHT	PRICE
S1097P	5 - Gallon Pail	51 lbs.	\$ 37.99
S1097D	55 - Gallon Drum	565 lbs.	\$ 354.99
S1097B	Bulk	-	- quoted -



BEFORE



AFTER



THE SMART CHOICE FOR PAVEMENT PRESERVATION

ASK ABOUT  
**LIQUID ROAD  
ULTRA**  
FACTORY BLENDED  
WITH SAND ADDED



## LIQUID ROAD®

### ASPHALT BASED PAVEMENT COATING

THE ULTIMATE COATING FOR ROADS, STREETS, & OTHER PAVEMENT SURFACES

**Advantages:**

- Polymer-modified and fiber-reinforced for ultimate durability
- A tough, aggregate-filled bituminous coating provides skid resistance and lasting protection

**UNCOATED VS. COATED**

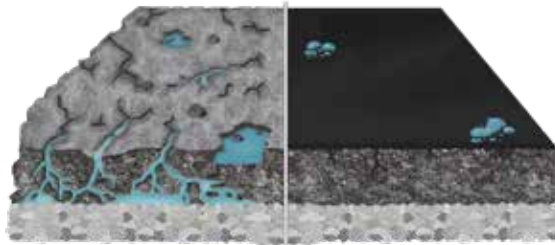

Liquid Road is mixed with specially graded aggregate and applied to the road surface. The result is a highly durable, slip-resistant surface treatment that greatly extends pavement service life. Liquid Road is cost-effective and easy to apply with minimal impact on traffic flow.

**Liquid Road Uses:**

- Low Traffic Roads
- Parking Lots
- Neighborhoods
- Airport Taxiways
- Gated Communities
- Highway Shoulders

**MIXING PROCEDURES:**

*[Based on 100 gallons of Liquid Road]*

- Liquid Road..... 100 gallons
- Sand.....400 lbs.

A 20-30 mesh AFS sand is recommended for parking lot applications. An 11-15 mesh AFS sand is recommended for road applications.

**NOTE:** A small amount of water may be added to facilitate application.

**MATERIAL REQUIREMENTS: For parking lot application** [20-30 mesh sand] - 55-66 square feet [6.11-7.33 square yards] per gallon per coat.

**For road application** [11-15 mesh sand] - 36-45 square feet [4-5 square yards] per gallon per coat.

PRODUCT #	DESCRIPTION	WEIGHT	PRICE
S1045P	5 - Gallon Pail	53 lbs.	\$ 41.99
S1045D	55 - Gallon Drum	580 lbs.	\$ 395.99
S1045B	Bulk	-	- quoted -





PROTECT, BEAUTIFY & RENEW ROADS



**Beautifies, protects, and extends the service life of asphalt roads**

**AsPen Uses:**

- Low-Traffic Roads
- Low-Traffic Streets
- Neighborhoods
- Gated Communities
- Airport Taxiways
- Highway Shoulders
- Cul-de-sac Roads
- Top Coat for Slurry and Chip Seal

**MIXING PROCEDURES:**

*(Based on 100 gallons of AsPen)*

AsPen ..... 100 gallons  
 Water ..... 50 gallons

**MATERIAL REQUIREMENTS (coverage):** One gallon of AsPen will cover approximately 75 - 115 square feet [8.33 to 12.77 square yards] per coat when properly mixed and applied.

**ASPEN®**

MINERAL FILLED SURFACE SEALER

**ECO-FRIENDLY MINERAL FILLED ROAD SURFACE REJUVENATOR FOR PAVEMENT PRESERVATION**

**Advantages:**

- Replenishes the valuable asphalt binder or "glue" that is lost through weathering, aging, traffic wear and other forms of environmental distress
- Provides a deep, rich "like new" black appearance
- Mineral filled for added durability
- Fast, efficient one-coat application process with minimal impact on traffic flow



PRODUCT #	DESCRIPTION	WEIGHT	PRICE
S1040P	5 - Gallon Pail	51 lbs.	\$ 37.99
S1040D	55 - Gallon Drum	565 lbs.	\$ 350.99
S1040B	Bulk	-	- quoted -



PROTECT, BEAUTIFY & RENEW ROADS



## OPTIPAVE™ SURFACE SEALER FOR ROADS

**ECO-FRIENDLY ROAD SURFACE SEAL  
FOR PAVEMENT PRESERVATION**

**Advantages:**

- Replenishes the valuable asphalt binder or "glue" that is lost through weathering, aging, traffic wear and other forms of environmental distress
- Fast, efficient, one-coat application process with minimal impact on traffic flow
- Provides a deep, rich, "like new" black appearance

***Beautifies, protects, and extends the service life of asphalt roads***

**OptiPave Uses:**

- Low-Traffic Roads
- Low-Traffic Streets
- Neighborhoods
- Gated Communities
- Airport Taxiways
- Highway Shoulders
- Cul-de-sac Roads
- Top Coat for Slurry and Chip Seal

**MIXING PROCEDURES:** OptiPave is ready to use. Do not dilute.

**MATERIAL REQUIREMENTS (coverage):** One gallon of OptiPave will cover approximately 50 - 75 square feet (5.55 to 8.33 square yards) per gallon.



PRODUCT #	DESCRIPTION	WEIGHT	PRICE
S1900P	5 - Gallon Pail	50 lbs.	\$ 37.99
S1900D	55 - Gallon Drum	555 lbs.	\$ 350.99
S1900B	Bulk	-	- quoted -



THE SEALER THAT'S  
READY TO USE!



LIGHTWEIGHT  
ALUMINUM  
SQUEEGEE  
PAGE 86

## SEALMASTER® E-Z STIR

### ASPHALT-BASED PAVEMENT SEALER

THE SEALER THAT'S READY TO USE!

**Advantages:**

- Ideal for maintenance crews and do-it-yourselfers
- Fortified with sand for slip resistance and durability
- Ideal for driveways and parking lots

### READY-TO-USE PAVEMENT SEALER - SIMPLY MIX AND APPLY...

SealMaster E-Z Stir pavement sealer is a ready-to-use, clay-stabilized asphalt emulsion pavement sealer fortified with sand for slip resistance. SealMaster E-Z Stir is designed to protect and beautify asphalt pavement.

**E-Z Stir Uses:**

- Parking Lots
- Roadways
- Driveways
- And More!

**MIXING PROCEDURES:** Simply stir, pour, and apply by squeegee, brush, or spray.

**MATERIAL REQUIREMENTS (coverage):** One gallon of E-Z Stir Pavement Sealer will cover approximately 70 - 82 square feet (7.8 to 9.1 square yards) per coat when properly mixed and applied.

**NOTE:** Coverage rate may vary due to pavement age, porosity, and method of application.

PRODUCT #	DESCRIPTION	WEIGHT	PRICE
S1070P	5 - Gallon Pail	56 lbs.	\$ 35.99
S1070D	55 - Gallon Drum	620 lbs.	\$ 334.99



SANDPUP  
PORTABLE  
SPRAY SYSTEM  
AVAILABLE ON PAGE 55



## ASK ABOUT COAL TAR ULTRA

FACTORY BLENDED  
WITH WATER,  
POLYMER ADDITIVE  
AND SAND

### Coal Tar Pavement Sealer Uses:

- Parking Lots
- Airports
- Driveways
- Shopping Malls

#### MIXING PROCEDURES:

*[Based on 100 gallons of Coal Tar Concentrate]*

Coal Tar Concentrate .....	100 gallons
Water .....	30-40 gallons
PaveGel Polymer Additive .....	1-2 gallons
Sand [40-70 mesh AFS] .....	200-500 lbs.

Mix thoroughly in agitated tank and apply by squeegee, brush or spray.

**MATERIAL REQUIREMENTS (coverage):** One gallon of Coal Tar Concentrate will cover approximately 100 - 120 square feet [11.1 to 13.3 square yards] per coat when properly mixed and applied.

## COAL TAR PAVEMENT SEALER

### FORMULATED FOR ADDED FUEL & UV RESISTANCE

#### Advantages:

- Deep, rich black color
- Oil and fuel resistant
- Reduced fume formulation for user-friendly application

### BEAUTIFIES & PROTECTS

SealMaster Coal Tar Sealer is a clay-stabilized, fuel resistant, coal tar emulsion pavement sealer fortified with special surfactants for superior adhesion and durability. SealMaster Coal Tar Sealer is ideal for protecting all types of asphalt pavement surfaces including parking lots, driveways, shopping malls, airports and more. Meets ASTM and Federal specifications.

PRODUCT #	DESCRIPTION	WEIGHT	PRICE
S1000P	5 - Gallon Pail	54 lbs.	\$ 37.99
S1000D	55 - Gallon Drum	595 lbs.	\$ 353.99
S1000B	Bulk	-	- quoted -



## ASK ABOUT PMCTS ULTRA

FACTORY BLENDED  
WITH SAND ADDED

### Polymer Modified Coal Tar Sealer Uses:

- Parking Lots
- Airports
- Driveways
- Shopping Malls

#### MIXING PROCEDURES:

*[Based on 100 gallons of PMCTS]*

PMCTS .....	100 gallons
Sand [40-70 mesh AFS] .....	200-400 lbs.

**NOTE:** If required, a small amount of water may be added to facilitate application of mixed material.

**MATERIAL REQUIREMENTS (coverage):** One gallon of PMCTS will cover approximately 85 - 95 square feet [9.4 to 10.5 square yards] per coat when properly mixed and applied.

**APPLICATION:** For optimum performance and durability, apply two coats of PMCTS with sand. A third coat of PMCTS with sand may be applied to high traffic areas such as entrances, exits and drive lanes.

## POLYMER-MODIFIED COAL TAR SEALER (PMCTS)

### PREMIUM QUALITY COAL TAR EMULSION PAVEMENT SEALER

### POLYMER MODIFIED FOR MAXIMUM DURABILITY

#### Advantages:

- Highly durable - applied at 48-55% solids (unlike conventional sealers that are applied at 40% solids)
- Dries fast
- Rubberized for added flexibility and adhesion
- Fuel resistant

### POLYMER MODIFICATION MAKES THE DIFFERENCE

Polymer-Modified Coal Tar Sealer (PMCTS) is a clay stabilized, fuel resistant coal tar emulsion pavement sealer blended with polymers and special surfactants for superior adhesion, flexibility and durability. PMCTS is ideal for protecting all types of asphalt including parking lots, driveways, shopping malls, airports and more.

PRODUCT #	DESCRIPTION	WEIGHT	PRICE
S1096P	5 - Gallon Pail	51 lbs.	\$ 39.99
S1096D	55 - Gallon Drum	565 lbs.	\$ 373.99
S1096B	Bulk	-	- quoted -



FACEBOOK HEADQUARTERS

**COLORPAVE**

# BRING COLOR TO YOUR PAVEMENT

100% Acrylic Emulsion Color Coating for asphalt pavement surfaces including: Driveways, Parking Lots, Paths, Walkways, and more!



## COLORPAVE® NEUTRAL CONCENTRATE

DESIGNED FOR MIXING WITH COLORPLUS PIGMENT DISPERSION, SAND AND WATER

100% ACRYLIC FOR MAXIMUM DURABILITY

### FUEL AND UV RESISTANT ACRYLIC COATING

ColorPave Neutral Concentrate is formulated for job-mixing with ColorPlus Pigment Dispersion, water, and sand.

**IMPORTANT: Do not apply to pavement surfaces that have previously been sealed with coal tar or asphalt based sealers.**

[See ColorPlus Pigment Dispersion - page 14].

**MIXING PROCEDURES:**

- ColorPave Neutral Concentrate.....55 gallons
- Water..... 33 gallons
- ColorPlus Pigment Dispersion.....4 gallons
- Sand [50-60 mesh].....800 lbs.

**MATERIAL REQUIREMENTS (coverage):** One gallon of ColorPave Concentrate when mixed properly will cover approximately 100 - 125 square feet [11 to 13.8 square yards] per coat. Two coats are recommended for optimum performance.

**NOTE:** Actual Coverage rates will vary due to differences in pavement porosity.

PRODUCT #	DESCRIPTION	WEIGHT	PRICE
S2105K	30 - Gallon Keg	280 lbs	\$ 404.99
S2105D	55 - Gallon Drum	525 lbs.	\$ 644.99
S2105T	275 - Gallon Tote	2,650 lbs.	\$ 3,256.99
S2105B	Bulk	-	- quoted -



## COLORPAVE® NEUTRAL READY-MIX

DESIGNED FOR MIXING WITH COLORPLUS PIGMENT DISPERSION

FORTIFIED WITH SAND FOR MAXIMUM DURABILITY

### FUEL AND UV RESISTANT COATING

ColorPave Neutral Ready-Mix is designed to be mixed with ColorPlus Pigment Dispersion. Available in 17 standard colors plus over 100 color variations using ColorPlus Fusion System.

**IMPORTANT: Do not apply to pavement surfaces that have previously been sealed with coal tar or asphalt based sealers.**

[See ColorPlus Pigment Dispersion - page 14].

**MIXING PROCEDURES:**

- ColorPave Neutral Ready-Mix.....1 pail
- ColorPlus Pigment Dispersion..... 1 pint

**NOTE:** If needed, a small amount of water may be added to facilitate application.

**MATERIAL REQUIREMENTS (coverage):** One pail [4 gallons] of ColorPave Neutral Ready-Mix will cover approximately 240 - 280 square feet [26.8 to 31.2 square yards] per coat. Two coats are recommended for optimum performance.

**NOTE:** Actual Coverage rates will vary due to differences in pavement porosity.

PRODUCT #	DESCRIPTION	WEIGHT	PRICE
S2092P	5 - Gallon Pail [4 - Gallon Net]	56 lbs	\$ 72.99



## COLORPLUS™ PIGMENT DISPERSION

A HIGHLY CONCENTRATED  
PIGMENT DISPERSION

Designed to disperse readily and completely in ColorPave Neutral Concentrate, Neutral Ready-Mix, and HD 500.

PRODUCT #	DESCRIPTION	WEIGHT	PRICE
C1374G	Forest Green, 1 - Gallon Pail	17 lbs.	\$ 72.99
C1372G	Light Green, 1 - Gallon Pail	17 lbs.	\$ 72.99
C1373G	Dark Green, 1 - Gallon Pail	17 lbs.	\$ 72.99
C1378G	Beige, 1 - Gallon Pail	17 lbs.	\$ 60.99
C1370G	Red, 1 - Gallon Pail	17 lbs.	\$ 60.99
C1386G	Maroon, 1 - Gallon Pail	17 lbs.	\$ 60.99
C1388G	Tournament Purple, 1 - Gallon Pail	17 lbs.	\$ 170.99
C1380G	Gray, 1 - Gallon Pail	17 lbs.	\$ 60.99
C1384G	Blue, 1 - Gallon Pail	17 lbs.	\$ 60.99
C1385G	Light Blue, 1 - Gallon Pail	17 lbs.	\$ 60.99
C1399G	Dove Gray, 1 - Gallon Pail	17 lbs.	\$ 60.99
C1383G	Ice Blue, 1 - Gallon Pail	17 lbs.	\$ 60.99
C1389G	Sandstone, 1 - Gallon Pail	17 lbs.	\$ 72.99
C1379G	Orange, 1 - Gallon Pail	17 lbs.	\$ 136.99
C1390G	Yellow, 1 - Gallon Pail	17 lbs.	\$ 73.99
C1392G	Brite Red, 1 - Gallon Pail	17 lbs.	\$ 291.99
C1660G	Black Dispersion, 1 - Gallon Pail	17 lbs.	\$ 20.99

NOTE: Colors will vary somewhat due to printing limitations. Ask your SealMaster Representative for a color chip card for more accurate representation.

<b>MAROON</b>	<b>GRAY</b>	<b>LIGHT BLUE</b>	<b>BRITE RED</b>	<b>BROWN</b> COLORPLUS FUSION	<b>DARK GREEN</b>
<b>TOURNAMENT PURPLE</b>	<b>BLUE</b>	<b>DOVE GRAY</b> LEED CREDIT *SRI=33	<b>ICE BLUE</b> LEED CREDIT *SRI=62	<b>ORANGE</b>	<b>FOREST GREEN</b>
 <p><b>COLORPLUS FUSION</b> For more than 100 additional color choices, visit <a href="http://www.sportmaster.net/colorplusfusion">www.sportmaster.net/colorplusfusion</a></p>			<b>SANDSTONE</b> LEED CREDIT *SRI=46	<b>YELLOW</b>	<b>LIGHT GREEN</b> LEED CREDIT *SRI=31
			<b>BEIGE</b>	<b>RED</b> LEED CREDIT *SRI=36	<b>BLACK</b>

## COLORPAVE® HD CLEAR COAT

ENHANCES AND PROTECTS YOUR  
COLORPAVE SURFACE

ColorPave HD Clear Coat is a 100% acrylic, clear drying emulsion specifically formulated as a protective top coat for ColorPave HD color coatings. It provides additional protection against ultra-violet rays, moisture, oil, gas, and chemical attack. ColorPave HD Clear Coat helps extend the service life of ColorPave HD color coatings. Clear Coat HD can be applied by spray, brush, or roller.



PRODUCT #	DESCRIPTION	WEIGHT	PRICE
S2300P	5 - Gallon Pail	46 lbs.	\$ 130.99

**MIXING PROCEDURES:**

Use as is. Do not dilute.

**MATERIAL REQUIREMENTS (coverage):** One gallon will cover approximately 200 square feet [22 square yards] per coat.

One 5 gallon pail will cover approximately 1,000 square feet [110 square yards] per coat.



## COLORPAVE® HD 500

IDEAL FOR COATING IMPRINTED ASPHALT SURFACES

ColorPave HD 500 is supplied as a Neutral Base designed to be mixed with ColorPlus Pigment Dispersion to achieve desired color. Pails contain 4 gallons of material to allow room for adding and mixing ColorPlus Pigment Dispersion. Add 1 pint of ColorPlus Pigment Dispersion to one pail of ColorPave HD 500.

**IMPORTANT: Do not apply to pavement surfaces that have previously been sealed with coal tar or asphalt based sealers.**

**Features:**

- Unique cross-linking technology provides high durability
- Fortified with sand for slip-resistance and durability
- Fast drying formula
- Designed for spray application (Due to Colorpave HD's unique fast drying technology, squeegee application is not recommended)

NOTE: ColorPave HD 500 is designed to be sprayed with any suitable texture coating spray unit.



PRODUCT #	DESCRIPTION	WEIGHT	PRICE
S2200P	5 - Gallon Pail (4 - gallon net)	56 lbs.	\$ 130.99

**MIXING PROCEDURES:**

ColorPave HD 500 .....1 pail  
ColorPlus Pigment Dispersion..... 1 pint

**NOTE:** If needed, a small amount of water may be added to facilitate application.

**MATERIAL REQUIREMENTS (coverage):** One gallon will cover approximately 60 - 70 square feet (6.7 to 7.8 square yards) per coat. Two coats are recommended for optimum performance.

NOTE: Actual coverage rates will vary due to differences in pavement porosity.

**(See page 14 for colors and pricing).**





## SAFERIDE™ BICYCLE LANE COATING

**Features:**

- Highly durable, 100% acrylic, crosslinking polymer technology
- Single component, ready-to-apply coating
- Bright green color provides a safe zone for bicyclists
- Meets MUTCD color recommendations for bike lane green

PRODUCT #	DESCRIPTION	WEIGHT	PRICE
S2280P	5 - Gallon Pail	72 lbs.	\$ 152.99

**MATERIAL REQUIREMENTS (coverage):** Typically one gallon will cover approximately 50 square feet per coat. Two to three coats are recommended for optimum durability and performance.



## SAFERIDE™ BUS LANE COATING

**Features:**

- Highly durable, 100% acrylic, crosslinking polymer technology
- Single component, ready-to-apply coating
- Highly visible, red color provides a designated lane for buses and a safe zone for loading passengers



PRODUCT #	DESCRIPTION	WEIGHT	PRICE
S2285P	5 - Gallon Pail	72 lbs.	\$ 152.99

**MATERIAL REQUIREMENTS (coverage):** Typically one gallon will cover approximately 50 square feet per coat. Two to three coats are recommended for optimum durability and performance.

# IT'S TIME TO GET TUUFF.



## TopTuff... The Ultimate Pavement Sealer Toughener

- Resists Power Steering Marks
- Suspends Sand
- Sealer Dries Blacker

**SEALER ADDITIVES**



SEALMASTER HAT & GLOVES  
PAGES 122+123

TOP TUFF PAVEMENT  
SEALER ADDITIVE - THE  
INDUSTRY WORKHORSE



## TOP TUFF™

### FILM TOUGHENER FOR PAVEMENT SEALERS

#### Features:

- Improves surface toughness
- Anchors in sand for extended wear
- Helps suspend sand
- Reduces power steering marks
- Provides a blacker dried sealer film
- Enhances resistance to oils, fuels, and grease

PRODUCT #	DESCRIPTION	WEIGHT	PRICE
M1100P	5 - Gallon Pail	48 lbs.	\$ 90.99
M1100D	55 - Gallon Drum	535 lbs.	\$ 936.99



PAVE GEL MEETS FAA P625, P627, AND P631 SPECS



**PAVE GEL™**  
RUBBERIZED POLYMER ADDITIVE

**Features:**

- Meets FAA P625, P627, and P631 specs
- Helps suspend and lock in sand
- Toughens pavement sealer
- Improves gas & oil resistance
- Reduces scuffing & power steering marks
- Dries faster, dries blacker

PRODUCT #	DESCRIPTION	WEIGHT	PRICE
M1105P	5 - Gallon Pail	47 lbs.	\$ 112.99
M1105D	55 - Gallon Drum	520 lbs.	\$ 1,205.99



**ZETAC™**  
IMPROVES RESISTANCE TO WATER

**Features:**

- Improves sealer durability by increasing water resistance
- Promotes greater adhesion to pavement surfaces
- Provides sand suspension and uniform application of sand slurry mixes

PRODUCT #	DESCRIPTION	WEIGHT	PRICE
M1180P	5 - Gallon Pail	47 lbs.	\$ 85.99
M1180D	55 - Gallon Drum	520 lbs.	\$ 904.99



## FASS-DRI™

### FEATURING ADVANCED NANO-CURE TECHNOLOGY

FASS-DRI Pavement Sealer Additive is the result of an exciting breakthrough in NANO-CURE chemistry. FASS-DRI additive enables you to open a parking lot to traffic in as little as 30 minutes.

- The latest advancement in fast dry technology for the fastest dry times
- Fortified with SSA (sand suspension additive) for dual action performance...  
Fast cure and sand suspension
- The blackest color - the toughest film
- Ideal for coal tar emulsion, asphalt emulsion, or blended sealers

PRODUCT #	DESCRIPTION	WEIGHT	PRICE
M1178G	2 - Gallon Pail	29 lbs.	\$ 54.99
M1178P	5 - Gallon Pail	72 lbs.	\$ 131.99



## FSA®

### SPEEDS UP THE DRYING TIME OF SEALER

Designed for situations requiring rapid drying i.e. drive-thrus, spring and fall applications.

- Cuts drying time in half
- Improves bonding
- Stops tracking
- Makes coating dry blacker
- Proven performance

PRODUCT #	DESCRIPTION	WEIGHT	PRICE
M1170P	5 - Gallon Pail	47 lbs.	\$ 79.99
M1170D	55 - Gallon Drum	520 lbs.	\$ 860.99



## FSA® AE

### FAST DRYING ADDITIVE FOR ASPHALT BASED SEALER

Designed for situations requiring rapid drying i.e. drive-thrus, spring and fall applications.

- Cuts drying time in half
- Improves bonding
- Stops tracking
- Makes coating dry blacker
- Proven performance
- Specifically formulated for use with asphalt emulsion based sealers

PRODUCT #	DESCRIPTION	WEIGHT	PRICE
M1172P	5 - Gallon Pail	47 lbs.	\$ 88.99
M1172D	55 - Gallon Drum	520 lbs.	\$ 949.99



## HOT-POUR CRACK FILLERS

# CRACKMASTER®

## PREMIUM QUALITY HOT POUR CRACK SEALANTS

### CRACKMASTER SUPREME DF

Our finest hot-applied crack filling material. Designed for use in both direct-fire and oil-jacketed kettles. Ideal for all crack filling applications on driveways and parking lots.

PRODUCT #	DESCRIPTION	PRICE
M1050L	50 lb. box with two 25 lb. cubes per box	\$ 1.08 per lb.

### CRACKMASTER 3405

Meets ASTM 3405 Specifications. Designed for use in oil-jacketed kettles. Ideal for use on roads and highways. Cold climates - flexible to -20°F.

PRODUCT #	DESCRIPTION	PRICE
M1060L	50 lb. box with two 25 lb. cubes per box	\$ 1.00 per lb.

\* Also available in state modified formula containing no crumb rubber [CrackMaster 3405 NR] or elevated levels of crumb rubber [CrackMaster 3405 R]\*

## PREMIUM QUALITY HOT-POUR CRACK SEALANTS

### Features:

- Superior performance
- Outstanding flexibility
- Rapid setup time
- Economical to use

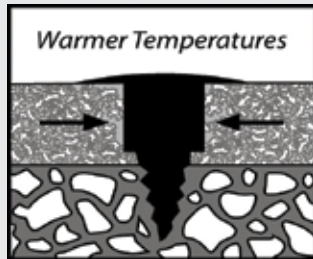
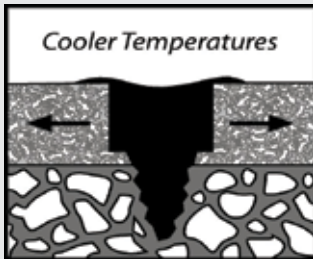

### CRACKMASTER SUPREME COVERAGE RATES

CRACK WIDTH	CRACK DEPTH	LBS./100 FT.
3/8"	3/8"	6.2 lbs.
1/2"	1/2"	11.1 lbs.
3/4"	3/4"	25.0 lbs.

### CRACKMASTER PARKING LOT GRADE, 3405 & PL COVERAGE RATES:

CRACK WIDTH	CRACK DEPTH	LBS./100 FT.
3/8"	3/8"	6.9 lbs.
1/2"	1/2"	12.3 lbs.
3/4"	3/4"	27.8 lbs.

### CRACKMASTER 3405 LM

Designed for use in oil-jacketed kettles. Ideal for use on roads and highways. Very cold climates - flexible to -40°F.

PRODUCT #	DESCRIPTION	PRICE
M1060LM	50 lb. box with two 25 lb. cubes per box	\$ 1.12 per lb.

### CRACKMASTER TRAFFIC LOOP SEALANT

Premium quality hot-melt loop sealant that resists tracking at elevated temperatures and remains flexible down to temperatures of -10°F. Can also be used in expansion joints and cracks. Recommended for oil-jacketed kettles.

PRODUCT #	DESCRIPTION	PRICE
M1051L	50 lb. box with two 25 lb. cubes per box	\$ .99 per lb.

### CRACKMASTER PL

An economical, high-softening-point material designed for use on parking lots and roads. Recommended for oil-jacketed kettles. Warm climates - flexible to 20°F.

PRODUCT #	DESCRIPTION	PRICE
M1070L	50 lb. box with two 25 lb. cubes per box	\$ .86 per lb.

### CRACKMASTER PL-HT

An economical, high-softening-point material designed for use on parking lots and roads. Recommended for oil-jacketed kettles. Warm climates - flexible to 20°F.

PRODUCT #	DESCRIPTION	PRICE
M1071L	50 lb. box with two 25 lb. cubes per box	\$ .86 per lb.

### CRACKMASTER PARKING LOT GRADE

A premium quality crack and joint sealing material that resists tracking at elevated temperatures and remains flexible down to -10°F. Designed for use in direct-fired kettles with agitation and oil-jacketed kettles. Ideal for large parking lots.

PRODUCT #	DESCRIPTION	PRICE
M1075L	50 lb. box with two 25 lb. cubes per box	\$ 1.04 per lb.

### CRACKMASTER PARKING LOT GRADE - LP

A premium quality crack and joint sealing material that resists tracking at elevated temperatures and remains flexible down to -10°F. Designed for use in direct-fired kettles with agitation and oil-jacketed kettles. Less surface tack than standard parking lot formulas, lower penetration at elevated temperatures.

PRODUCT #	DESCRIPTION	PRICE
M1074L	50 lb. box with two 25 lb. cubes per box	\$ 1.04 per lb.



### CRACK PRO® HEATED HOSE MACHINE

AVAILABLE ON PAGE 69

### CRACKMASTER 1190

Designed for use on roads and highways. Recommended for oil-jacketed kettles. Moderate climates - flexible to 0°F.

PRODUCT #	DESCRIPTION	PRICE
M1078L	50 lb. box with two 25 lb. cubes per box	\$.99 per lb.

\* Also available in state modified formula containing no crumb rubber (CrackMaster 1190 NR) or elevated levels of crumb rubber (CrackMaster 1190 R)\*

### CRACKMASTER 1190 MP (MELTABLE PACKAGING)

Designed for use on roads and highways. In meltable packaging. Recommended for oil-jacketed kettles. Moderate climates - flexible to 0°F.

PRODUCT #	DESCRIPTION	PRICE
M1078MP	1 - 32 lb. Plastic Pail	\$1.16 per lb.

### CRACKMASTER 5078

Designed for use in oil-jacketed kettles. Ideal for use on roads and highways. Cool climates - flexible to 10°F.

PRODUCT #	DESCRIPTION	PRICE
M1067L	50 lb. box with two 25 lb. cubes per box	\$.88 per lb.

### CRACKMASTER PF

Polymer modified fiber sealant containing approximately 5% polyester fibers. Designed for use in oil-jacketed kettles. Ideal for use on roads and highways. Moderate to hot climates - flexible to 0°F.

PRODUCT #	DESCRIPTION	PRICE
M1077L	50 lb. box with two 25 lb. cubes per box	\$1.18 per lb.

### CRACKMASTER PF IV

Meets Ohio DOT, type IV specification. Contains approximately 2% polyester fiber content. Designed for use in oil-jacketed kettles. Ideal for use on roads and highways. Remains flexible in all climates.

PRODUCT #	DESCRIPTION	PRICE
M1076L	50 lb. box with two 25 lb. cubes per box	\$1.18 per lb.

### CRACKMASTER MA

Marker adhesive designed for use in both direct-fired kettles with agitation and oil-jacketed kettles. Ideal for use on roads and highways. Flexible in moderate to hot climates.

PRODUCT #	DESCRIPTION	PRICE
M1055L	50 lb. box with two 25 lb. cubes per box	\$.99 per lb.

### CRACKMASTER CJA

A cold joint adhesive designed for use in oil-jacketed kettles. Ideal for use on roads and highways. Remains flexible in all climates.

PRODUCT #	DESCRIPTION	PRICE
M1061L	50 lb. box with two 25 lb. cubes per box	\$1.02 per lb.

\* Also available in state modified formula for Alaska, CrackMaster CJA II\*

### CRACKMASTER BLEND

Bonding agent or anchor device between the overrun surface of an airport runway and the emergency arresting concrete blocks. Designed for use in oil-jacketed kettles.

PRODUCT #	DESCRIPTION	PRICE
M1072L	50 lb. box with two 25 lb. cubes per box	\$1.10 per lb.

### CRACKMASTER 544

Polymer modified, polyester-fibered sealant designed for use with oil-jacketed kettles. Contains approximately 1/2% polyester fiber content. Ideal for use on roads and highways.

PRODUCT #	DESCRIPTION	PRICE
M1057L	50 lb. box with two 25 lb. cubes per box	\$.86 per lb.

### CRACKMASTER TRM

Designed for use with oil-jacketed kettles. Contains a high crumb rubber content. Ideal for use on roads and highways.

PRODUCT #	DESCRIPTION	PRICE
M1054L	50 lb. box with two 25 lb. cubes per box	\$.99 per lb.

### CRACKMASTER 3725

Recommended for oil-jacketed kettles. Designed for use on roads and highways. Very cold climates - flexible to -40°F.

PRODUCT #	DESCRIPTION	PRICE
M1062L	50 lb. box with two 25 lb. cubes per box	\$1.20 per lb.

### CRACKMASTER 6690 TYPE 1

The ideal product for the contractor who wants a single product to use in both road and parking lot applications. Meets ASTM D 6690 Type 1 (formerly ASTM D 1190). Can be used in oil-jacketed kettles or direct fire kettles with agitation.

PRODUCT #	DESCRIPTION	PRICE
M1052L	50 lb. box with two 25 lb. cubes per box	\$1.01 per lb.







## CRACK FILLING

prevents moisture intrusion into pavement cracks by providing a water-proof barrier

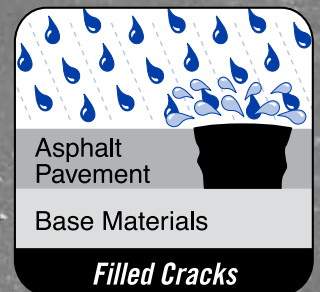
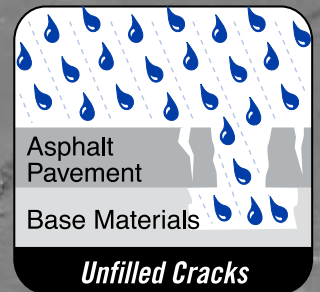

CRACK BANDING MACHINE  
PAGE 88



# COLD-POUR CRACK FILLERS

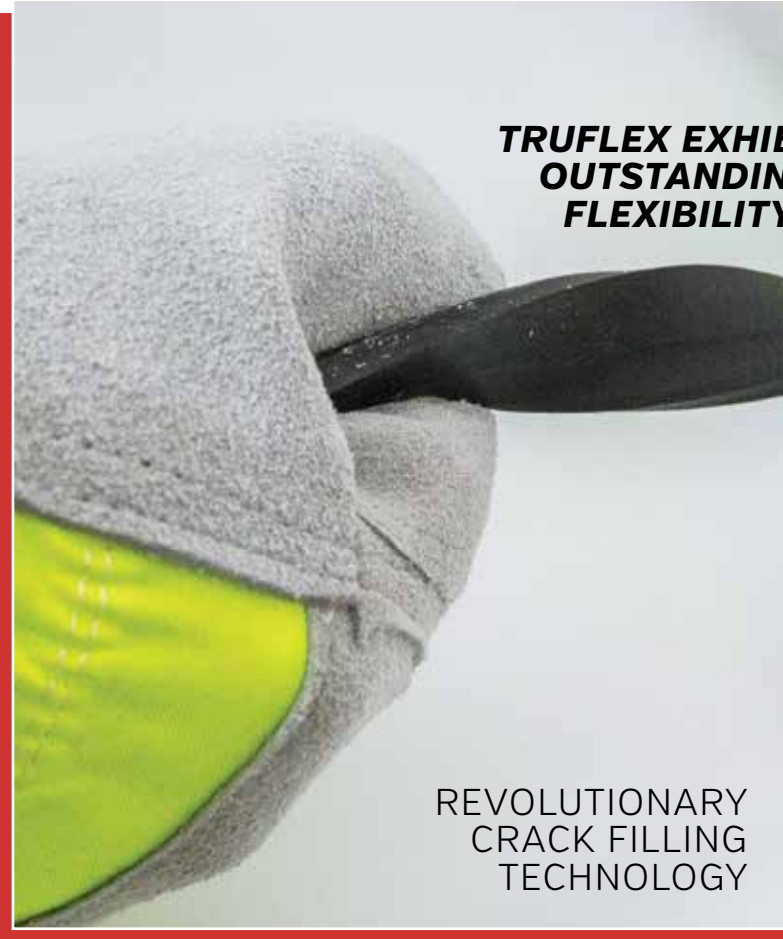

**TRUFLEX EXHIBITS  
OUTSTANDING  
FLEXIBILITY**

**REVOLUTIONARY  
CRACK FILLING  
TECHNOLOGY**



Shown with 10 lbs. of sand added to TruFlex. Sand addition makes TruFlex ideal for repairing larger cracks and alligatored areas.



**TRUFLEX® RUBBERIZED  
CRACK SEALANT**

**COLD POUR CONVENIENCE -  
HOT POUR PERFORMANCE**

TruFlex is a highly rubberized crack sealant designed for sealing cracks in asphalt or concrete pavements. TruFlex can also be mixed with sand for filling larger cracks and alligatored areas.

**Features:**

- Ideal for use as a high performance crack sealant for asphalt and concrete pavements
- Also designed for mixing with sand to repair larger cracks and alligatored pavement
- High softening point and toughness helps resist ripping and tearing in high temperatures
- Superior UV and fuel resistance

PRODUCT #	DESCRIPTION	WEIGHT	PRICE
M1008G	1 - Gallon Jug	10 lbs.	\$ 23.99
M1008P	5 - Gallon Pail	50 lbs.	\$ 87.99
M1008D	55 - Gallon Drum	550 lbs.	\$ 951.99



## FLEXMASTER®

ELASTOMERIC CRACK SEALANT FOR ASPHALT AND CONCRETE PAVEMENTS

### Features:

- Highly polymer-modified asphalt emulsion featuring outstanding adhesion and flexibility
- Exhibits low temperature flexibility
- Environmentally friendly water-based formula



PRODUCT #	DESCRIPTION	WEIGHT	PRICE
M1001G	1 - Gallon Jug	10 lbs.	\$ 21.99
M1001P	5 - Gallon Pail	50 lbs.	\$ 80.99
M1001D	55 - Gallon Drum	550 lbs.	\$ 861.99



## POURABLE CRACK SEALANT

RUBBERIZED CRACK SEALANT FOR ASPHALT AND CONCRETE PAVEMENTS

### Features:

- Rubberized asphalt emulsion sealant for added flexibility



PRODUCT #	DESCRIPTION	WEIGHT	PRICE
M1010G	1 - Gallon Jug	11 lbs.	\$ 19.99
M1010P	5 - Gallon Pail	53 lbs.	\$ 51.99
M1010D	55 - Gallon Drum	590 lbs.	\$ 518.99

## LOOPMASTER™

TRAFFIC LOOP SEALANT

Protective sealant for traffic induction loops at intersections and on parking areas

### Features:

- Rubberized asphalt emulsion provides a water-proof protective seal over traffic loop wires in pavement
- One component sealant that is economical and easy to apply



PRODUCT #	DESCRIPTION	WEIGHT	PRICE
M1014G	1 - Gallon Jug	11 lbs.	\$ 19.99
M1014P	5 - Gallon Pail	53 lbs.	\$ 51.99
M1014D	55 - Gallon Drum	590 lbs.	\$ 518.99

**HOT-APPLIED CRACKMASTER TRAFFIC LOOP SEALANT** AVAILABLE ON PAGE 22

## GATORPAVE™

READY-TO-USE PATCHING MATERIAL FOR CRACKED & ALLIGATORING PAVEMENT



**Features:**

- High solids, polymer-modified, fiber reinforced asphalt emulsion designed to fill and repair large cracks and alligatored areas in asphalt pavement
- Fortified with aggregate and recycled rubber particles



PRODUCT #	DESCRIPTION	WEIGHT	PRICE
M1160P	5 - Gallon Pail	62 lbs.	\$ 70.99
M1160D	55 - Gallon Drum	680 lbs.	\$ 725.99

## TROWEL GRADE CRACK FILLER

HEAVY-BODIED MATERIAL FOR FILLING AND REPAIRING LARGE CRACKS IN PAVEMENT



**Features:**

- Viscous, heavy-bodied trowel grade formulation
- Polymer-modified asphalt emulsion fortified with mineral filler, aggregate and recycled rubber particles for maximum filling and flexible properties



PRODUCT #	DESCRIPTION	WEIGHT	PRICE
M1020P	5 - Gallon Pail	65 lbs.	\$ 51.99

## ACRYLIC CRACK FILLER

THE ULTIMATE CRACK FILLER



**Features:**

- Formulated with 100% tough, durable, elastomeric acrylic polymers
- Outstanding UV and fuel resistance
- Remains flexible at low temperatures
- Designed for use in all cracks including alligatored areas



PRODUCT #	DESCRIPTION	WEIGHT	PRICE
M1002G	1 - Gallon Jug	11 lbs.	\$ 31.99

**MIXING PROCEDURES FOR COLD-APPLIED CRACK SEALANTS, FILLERS, AND PATCHING MATERIALS:**  
Do not dilute. Stir thoroughly.

**MATERIAL REQUIREMENTS (coverage):** Coverage is dependent upon depth and width of cracks. Typically, one gallon of crack filling material will fill approximately 75-150 linear feet of cracks depending on depth and width of cracks

# YOUR SOURCE FOR QUALITY COLD-PATCH MATERIALS



HEAVY-DUTY HAND TAMPER  
PAGE 90

**PREPARATION & REPAIR**



1

**WATER ACTIVATED  
CURING TECHNOLOGY!**



2



3



## AQUASET® PREMIUM COLD PATCH

**PREMIUM, HIGH PERFORMANCE, WATER-ACTIVATED  
PATCHING MATERIAL**

**Advantages:**

- Exceptionally easy to apply
- Sets up within minutes after the addition of water
- Highly durable, permanent repair
- All weather formula (wet or dry, hot or cold), water activated formula
- Ultra durable bond for enduring repair
- Convenient formula requires no heavy equipment or large crews
- Available in three grades

PRODUCT #	DESCRIPTION
M1190	4 mm - Cracks and potholes less than 1 inch deep
M1191	6 mm - 1 to 3 inch deep potholes
M1192	9 mm - Deep holes and as base repairs

*\* Call for pricing*



## AQUAPHALT™ PREMIUM COLD PATCH

**PERFORMANCE ENGINEERED  
ASPHALT REPAIR MATERIAL**

**Advantages:**

- Extremely easy to apply
- Permanently hardens in minutes instead of days
- Engineered to be supremely tough and durable
- Usable in any weather
- Water activated curing technology
- Bonds with the surface to create a genuine repair, not just a temporary fix
- Available in 3 grades for precision repair

PRODUCT #	DESCRIPTION	WEIGHT
M1155	4 mm - Cracks and potholes less than 1 inch deep	50 lbs.
M1156	6 mm - 1 to 3 inch deep potholes	50 lbs.
M1157	9 mm - Deep holes and as base repairs	50 lbs.

*\* Call for pricing*



## PATCHMASTER™

### HIGH PERFORMANCE POTHOLE PATCH

#### THE COLD PATCH WITH HOT MIX PERFORMANCE

##### Advantages:

- Easy to use - simply pour from bag and tamp or drive over with car wheels. No heating required
- PatchMaster can be applied in any weather
- Fills potholes in both asphalt and concrete. Ideal for full depth repair
- Packaged in 50 lb. weatherproof bags and 55-gallon drums
- Ideal for roads, streets, parking lots, driveways, and other pavement surfaces

PRODUCT #	DESCRIPTION	WEIGHT	PRICE
M1150	50 lb. Bag	50 lbs.	\$ 15.99
M1150D	55 - Gallon Drum	700 lbs.	\$ 203.99

**MIXING PROCEDURES:** No mixing required. Simply pour from pail or bag, spread, and tamp in place.

**MATERIAL REQUIREMENTS (coverage):** One 50 lb. bag will cover approximately 5 square feet at 1" depth or 2.5 square feet at 2" depth.



#### HAND TAMPERS & ASPHALT LUTES

AVAILABLE ON PAGE 90



## ASPHALT BINDER™

AN ASPHALT EMULSION TACK COAT DESIGNED FOR PRIMING BITUMINOUS PAVEMENT SURFACES

**Features:**

- Tack coat for patching, paving and coating processes
- Promotes adhesion of bituminous concrete products and coatings
- Meets the ISSA Requirements for SS1H
- Environmentally friendly, water-based formulation

**MIXING PROCEDURES:**

*Primer for coatings:*

Asphalt Binder ..... 10 gallons  
 Water ..... 80 gallons

*For use as a tack coat for patching or paving:*

Asphalt Binder ..... 10 gallons  
 Water ..... 10 gallons

**MATERIAL REQUIREMENTS (coverage):** Dependent upon water dilution.

PRODUCT #	DESCRIPTION	WEIGHT	PRICE
M1140P	5 - Gallon Pail	46 lbs.	\$ 47.99
M1140D	55 - Gallon Drum	515 lbs.	\$ 450.99
M1140B	Bulk	-	- quoted -



## ASPHALT BINDER PLUS™

MULTI-PURPOSE POLYMER-MODIFIED ASPHALT EMULSION FORMULATED FOR ADDED FLEXIBILITY, ADHESION & RESILIENCE

**Uses:**

- Asphalt Recycling Agent
- Pavement Rejuvenator/Fog Seal
- Crack Sealant for Road Application
- Tack Coat

***Can also be used as an Economical Crack Sealant for Roads***

**MIXING PROCEDURES:**

*Recycling agent for infrared patching:* Use as is. No dilution required.

*For use as a tack coat for patching or paving:* Dilute 1 to 1 with water. Apply by spray or brush. Apply at a rate of .06 to .10 gallons of mixed material per square yard (.03 to .05 concentrate).

**MATERIAL REQUIREMENTS (coverage):** Reference the Material Specification Sheet.

PRODUCT #	DESCRIPTION	WEIGHT	PRICE
M1145P	5 - Gallon Pail	46 lbs.	\$ 58.99
M1145D	55 - Gallon Drum	515 lbs.	\$ 579.99



## HEATED ASPHALT DISTRIBUTORS

AVAILABLE ON PAGE 62 + 63



# OIL SPOT PRIMERS

Seals oil, gas, and grease spots on pavement prior to sealcoating. Helps prevent oil spots from bleeding up through freshly applied pavement sealer.



## PREP SEAL™

### READY-TO-USE OIL SPOT PRIMER

#### Features:

- Ready-to-use acrylic-based emulsion forms barrier over oil and grease spots
- Helps prevent oil and grease spots from bleeding up through freshly applied pavement sealer
- Applied by roller, brush, or spray
- Environmentally friendly, water-based formulation

PRODUCT #	DESCRIPTION	WEIGHT	PRICE
M1130G	1 - Gallon Jug	9 lbs.	\$ 15.99
M1130P	5 - Gallon Pail	46 lbs.	\$ 35.99

**MIXING PROCEDURES:** Prep Seal is a ready-to-use product. Do not dilute. Use as is. Stir thoroughly before applying.

**MATERIAL REQUIREMENTS (coverage):** One gallon of Prep Seal will cover approximately 150-200 square feet.



## PETRO SEAL™

### CONCENTRATED OIL SPOT PRIMER

#### Features:

- Concentrated, acrylic-based emulsion forms barrier over oil and grease spots
- Helps prevent oil and grease spots from bleeding up through freshly applied pavement sealer
- Applied by roller, brush, or spray
- Can be diluted up to 2 parts water to 1 part Petro Seal
- Environmentally friendly, water-based formulation

PRODUCT #	DESCRIPTION	WEIGHT	PRICE
M1120P	5 - Gallon Pail	47 lbs.	\$ 85.99
M1120D	55 - Gallon Drum	520 lbs.	\$ 883.99

**MIXING PROCEDURES:** Can be diluted up to one part Petro Seal and two parts water. However, a 1 to 1 dilution rate is typically recommended. Mix thoroughly before applying.

**MATERIAL REQUIREMENTS (coverage):** One gallon of Petro Seal when mixed 1 to 1 with water will cover approximately 300-400 square feet.



## TARBUSTER™

### THE ENVIRONMENTALLY FRIENDLY, FULL STRENGTH TAR AND ASPHALT REMOVER

TarBuster's Industrial formulation safely penetrates, dissolves, and removes the toughest: oil, asphalt, grease, sludge, and asphalt pavement sealer (not recommended for the removal of coal tar).

**Features:**

- Biodegradable
- Non-Toxic
- Non-Corrosive
- Pine Scent Aroma

**TarBuster is FAST ACTING:**

In as little as 30 seconds you'll see how TarBuster cuts cleanup time in the toughest cleaning applications.

PRODUCT #	DESCRIPTION	WEIGHT	PRICE
T2087	TarBuster Wipes - 30 count	2 lbs.	\$ 12.99
T2078	1 - Gallon Jug	9 lbs.	\$ 55.99
T2080	1 - Gallon Jugs (case of 4)	34 lbs.	\$ 220.99
T2082	5 - Gallon Pail	41 lbs.	\$ 223.99
T2084	55 - Gallon Drum	440 lbs.	\$ 1,613.99



## TARPEDO™

### DESTROYS AND QUICKLY DISSOLVES COAL TAR SEALER

**Features:**

- Use on tools, equipment and vehicles
- Rinses easily with water
- High flash point [145°F] formula
- Also removes asphalt and other tough substances

**Quick and Effective:**

Tarpedo quickly and effectively dissolves ready-mix and concentrated coal tar sealers.

PRODUCT #	DESCRIPTION	WEIGHT	PRICE
T2090	1 - Gallon Jug	9 lbs.	\$ 54.99
T2092	1 - Gallon Jugs (case of 4)	34 lbs.	\$ 216.99
T2094	5 - Gallon Pail	41 lbs.	\$ 234.99



## MASTERFLO™

### PAVEMENT SEALER REMOVER

**Features:**

- Removes coal tar, asphalt, and much more from a variety of surfaces
- Water-soluble, ready-to-use formula
- Can be used as a degreaser

PRODUCT #	DESCRIPTION	WEIGHT	PRICE
T2060	1 - Pint	2 lbs.	\$ 24.99
T2050	1 - Gallon Jug	9 lbs.	\$ 61.99
T2065	5 - Gallon Pail	41 lbs.	\$ 214.99
T2055	55 - Gallon Drum	440 lbs.	\$ 1,855.99

**APPLICATION INSTRUCTIONS:** Apply to surface and allow to penetrate for 30 seconds to 2 minutes. Scrub with brush or cloth. Rinse thoroughly with water.



GRACO  
STRIPING  
MACHINES

AVAILABLE  
ON PAGES 74-75



# WE'VE EARNED OUR STRIPES.

Over 40 Years of Striping Paint **Innovation.**



TRAFFIC PAINTS



**BRIGHT, DURABLE TRAFFIC MARKINGS**

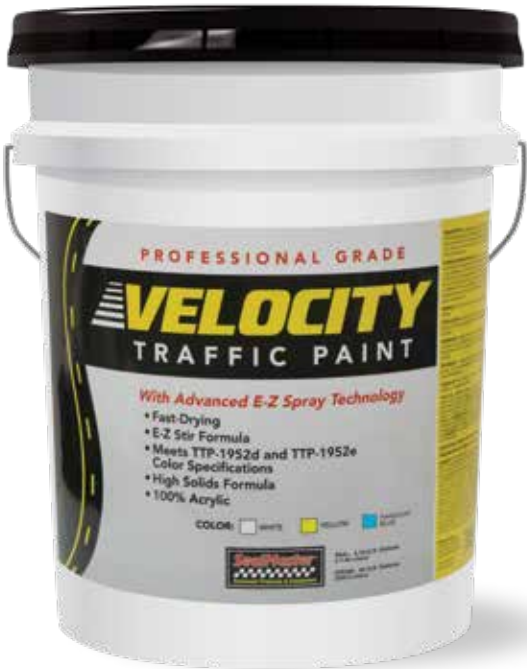

## VELOCITY™

### FAST DRYING E-Z SPRAY TRAFFIC PAINT

**BRIGHT, DURABLE TRAFFIC MARKINGS**

**Advantages:**

- Advanced E-Z Spray Technology for optimum atomization and crisp, consistent lines
- Fast-Drying Formula meets Fed Spec TTP-1952d and TTP-1952e color specifications
- High solids, durable formula
- E-Z stir formula with minimal settling in pail during storage
- 100% acrylic formula

**Velocity Uses:**

- Asphalt or Concrete Highways
- Roads
- Streets
- Parking Lots
- and More!

PRODUCT #	DESCRIPTION	WEIGHT	PRICE
M1275P	White 5 - Gallon Pail	72 lbs.	\$ 98.99
M1275D	White 55 - Gallon Drum	800 lbs.	\$ 1,049.99
M1285P	Yellow 5 - Gallon Pail	72 lbs.	\$ 98.99
M1285D	Yellow 55 - Gallon Drum	800 lbs.	\$ 1,049.99
M1278P	Handicap Blue 5 - Gallon Pail	72 lbs.	\$ 104.99
M1278D	Handicap Blue 55 - Gallon Drum	800 lbs.	\$ 1,115.99

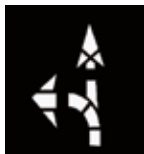

**TRAFFIC MARKING STENCILS**

AVAILABLE ON PAGES 97-99

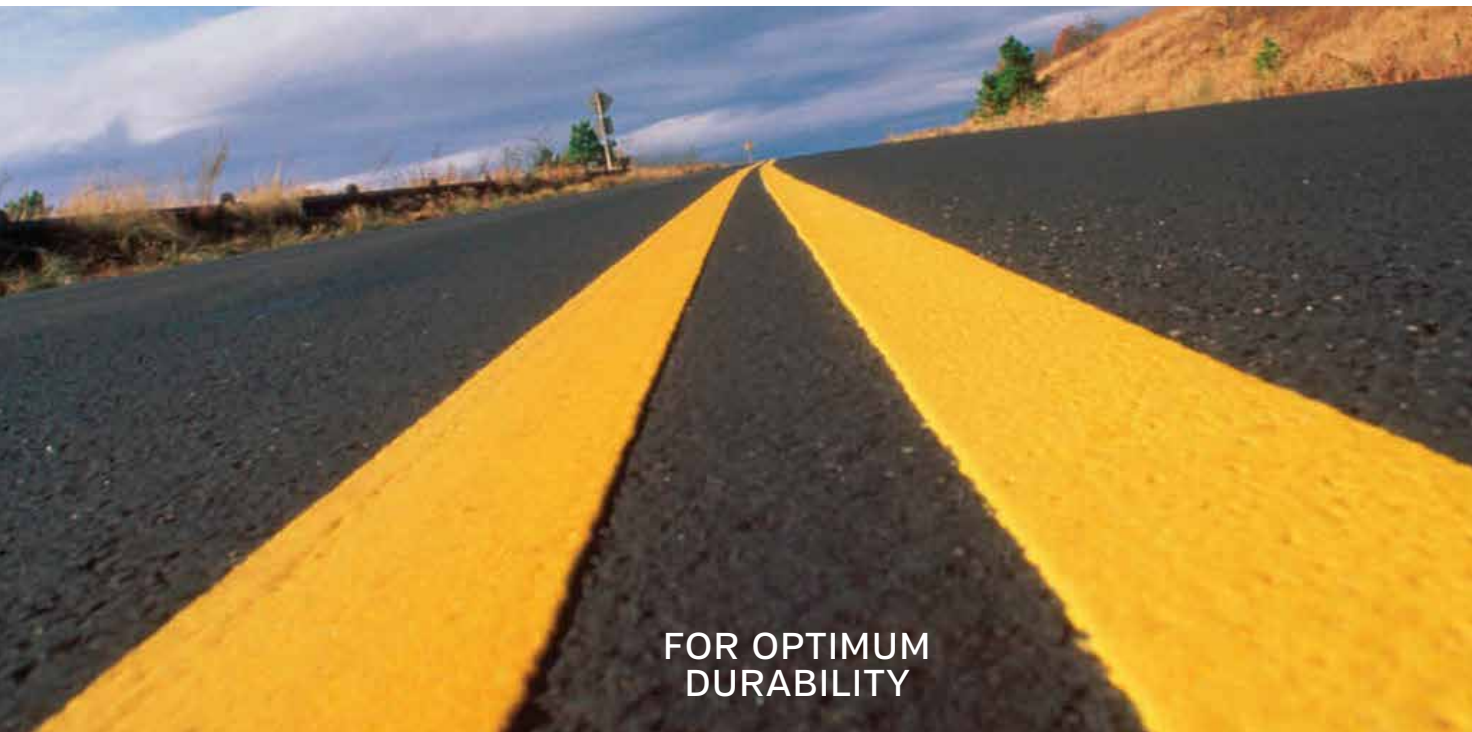

FOR OPTIMUM  
DURABILITY



## LIQUID THERMOPLASTIC

HIGH PERFORMANCE TRAFFIC MARKING PAINT

THE ULTIMATE IN PERFORMANCE AND DURABILITY

### Advantages:

- Cold-spray-applied Liquid Thermoplastic featuring hot-applied thermoplastic performance
- Meets fed spec TTP-1952d and TTP-1952e
- Liquid Thermoplastic Traffic Marking Paint can be applied with standard airless spray equipment

PRODUCT #	DESCRIPTION	WEIGHT	PRICE
M1297P	White 5 - Gallon Pail	72 lbs.	\$ 130.99
M1297D	White 55 - Gallon Drum	800 lbs.	\$ 1,390.99
M1296P	Yellow 5 - Gallon Pail	72 lbs.	\$ 130.99
M1296D	Yellow 55 - Gallon Drum	800 lbs.	\$ 1,390.99
M1298P	Blue 5 - Gallon Pail	72 lbs.	\$ 132.99
M1298D	Blue 55 - Gallon Drum	800 lbs.	\$ 1,395.99
M1299P	Red 5 - Gallon Pail	72 lbs.	\$ 174.99
M1299D	Red 55 - Gallon Drum	800 lbs.	\$ 1,773.99
M1294P	Black 5 - Gallon Pail	72 lbs.	\$ 126.99
M1294D	Black 55 - Gallon Drum	800 lbs.	\$ 1,328.99

### Liquid Thermoplastic Uses:

- Highways
- Roads
- Streets
- Intersections
- Arrows and Legends
- Cross Walks
- and More!

**MIXING PROCEDURES:** Use as is. Do not dilute.  
Apply by spray, roller, or brush.

**MATERIAL REQUIREMENTS (coverage):** One gallon will provide 155-180' of 4" line at 30-35 mils wet thickness.



## ACRYLIC TRAFFIC PAINT

High Performance 100% acrylic emulsion paint designed for bright, durable traffic markings on asphalt or concrete roadways and parking lots. Available in white and yellow.

PRODUCT #	DESCRIPTION	WEIGHT	PRICE
M1200P	White 5 - Gallon Pail	65 lbs.	\$ 64.99
M1200D	White 55 - Gallon Drum	715 lbs.	\$ 667.99
M1210P	Yellow 5 - Gallon Pail	65 lbs.	\$ 64.99
M1210D	Yellow 55 - Gallon Drum	715 lbs.	\$ 667.99



## TTP-1952B TRAFFIC PAINT

100% acrylic premium grade traffic paint. **Meets federal specifications.** Provides bright, durable traffic markings. Available in white and yellow.

PRODUCT #	DESCRIPTION	WEIGHT	PRICE
M1240P	White 5 - Gallon Pail	66 lbs.	\$ 74.99
M1240D	White 55 - Gallon Drum	725 lbs.	\$ 784.99
M1250P	Yellow 5 - Gallon Pail	65 lbs.	\$ 74.99
M1250D	Yellow 55 - Gallon Drum	715 lbs.	\$ 784.99



## FAST DRY TRAFFIC PAINT

High solids 100% acrylic traffic paint. Dries in less than 5 minutes. Available in white and yellow. **Meets TTP-1952d and TTP-1952e.**

PRODUCT #	DESCRIPTION	WEIGHT	PRICE
M1270P	White 5 - Gallon Pail	72 lbs.	\$ 102.99
M1270D	White 55 - Gallon Drum	800 lbs.	\$ 1,096.99
M1280P	Yellow 5 - Gallon Pail	72 lbs.	\$ 102.99
M1280D	Yellow 55 - Gallon Drum	800 lbs.	\$ 1,096.99

**MIXING PROCEDURES:** Use as is. Do not dilute. Apply by spray, roller, or brush.

**MATERIAL REQUIREMENTS (coverage):** One gallon will provide 325' of 4" line at 15 mils wet thickness.



## LINE BLOCK OUT PAINT

Black 100% acrylic marking paint designed to block out unwanted lines. Ideal for changing traffic patterns on parking lots.

PRODUCT #	DESCRIPTION	WEIGHT	PRICE
M1260P	5 - Gallon Pail	55 lbs.	\$ 52.99
M1260D	55 - Gallon Drum	615 lbs.	\$ 521.99

NEW PRODUCT



## ACRYLIC LOW VOC

SealMaster® Acrylic Low VOC Traffic Paint is a user friendly, fast drying, low VOC acrylic/acetone based traffic paint. May be used to stripe roadways, airports and parking lots with or without pressure applied glass beads.

This product meets A-A-2886 [B] Type 11, WA DOT Specification 9-34.2[4] for Low VOC acrylic/acetone based Traffic Paint.

PRODUCT #	DESCRIPTION	WEIGHT	PRICE
M1205P	White 5 - Gallon Pail	67 lbs.	\$ 116.99
M1225P	Yellow 5 - Gallon Pail	67 lbs.	\$ 116.99
M1255P	Black 5 - Gallon Pail	67 lbs.	\$ 119.99
M1245P	Blue 5 - Gallon Pail	67 lbs.	\$ 142.99
M1257P	Red 5 - Gallon Pail	67 lbs.	\$ 123.99

**MIXING PROCEDURES:** Use as is. Do not dilute. Apply by spray, roller, or brush.



## HANDICAP BLUE

Professional Grade, 100% acrylic water-based paint. Formulated for lasting durability.

PRODUCT #	DESCRIPTION	WEIGHT	PRICE
M1230G	Blue 1 - Gallon Pail	12 lbs.	\$ 20.99
M1230P	Blue 5 - Gallon Pail	60 lbs.	\$ 87.99



## FIRELANE RED

Designed for marking firelane areas on parking lots. 100% acrylic emulsion paint. Bright, vibrant color.

PRODUCT #	DESCRIPTION	WEIGHT	PRICE
M1220G	Red 1 - Gallon Pail	12 lbs.	\$ 29.99
M1220P	Red 5 - Gallon Pail	60 lbs.	\$ 130.99

**MATERIAL REQUIREMENTS (coverage):** One gallon will provide 325' of 4" line at 15 mils wet thickness.



## GAMETIME

### FIELD MARKING PAINT

**WITH OPTICAL BRIGHTENERS FOR HIGHLY VISIBLE GAME LINES**

**Features:**

- Ready to use
- Bright, durable field marking paint
- Exceptional brightness under natural and artificial light
- Environmentally friendly water-based formula
- No harm to grass or its growth

PRODUCT #	DESCRIPTION	WEIGHT	PRICE
M1195P	White 5 - Gallon Pail	55 lbs.	\$ 49.99
M1195D	White 55 - Gallon Drum	615 lbs.	\$ 490.99
M1196P	Yellow 5 - Gallon Pail	55 lbs.	\$ 49.99
M1196D	Yellow 55 - Gallon Drum	615 lbs.	\$ 490.99
M1197P	*Neutral Base 4 - Gallon [Net] Pail	45 lbs.	\$ 33.99
M1197D	*Neutral Base 55 - Gallon Drum	615 lbs.	\$ 346.99

*\* Neutral Base is designed to be tinted with ColorPlus Pigment Dispersion [see page 102].*



**FIELD MARKING STRIPING MACHINES**

AVAILABLE ON PAGE 75 + 77

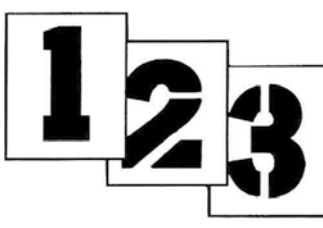

**NUMBER STENCILS**

AVAILABLE ON PAGE 99





## ENVIRONMENTALLY FRIENDLY

100% ACRYLIC EMULSION FORMULATIONS



Ideal for interior and exterior concrete surfaces



**CONCRETE PRODUCTS**

## CONCRETE SEALER

100% ACRYLIC WATER-BASED EMULSION

**Features:**

- Meets ASTM C309 Type I Class A
- Beautifies concrete
- Protects against moisture penetration and water damage
- Protects against surface scaling and spalling
- Dust-proofs concrete surfaces
- Provides stain and chemical resistance
- Excellent resistance to water blushing (whitening), when exposed to rain or moisture.
- Environmentally friendly, VOC compliant
- Outstanding wearability
- Non-yellowing formula

PRODUCT #	DESCRIPTION	WEIGHT	PRICE
M1300P	5 - Gallon Pail	46 lbs.	\$ 75.99
M1300D	55 - Gallon Drum	510 lbs.	\$ 750.99

**MIXING PROCEDURES:** Concrete Sealer is ready-to-use. Do not dilute. Stir thoroughly before applying.

**MATERIAL REQUIREMENTS (coverage):** One gallon of Concrete Sealer will cover 200 square feet.

## CONCRETE PATCH

100% ACRYLIC TROWEL GRADE FORMULA

**Features:**

- Heavy-bodied trowel grade patch material fortified with mineral filler
- Designed for filling larger cracks up to 1" wide in concrete surfaces
- Fills and repairs damaged and spalled areas in concrete up to 1/4" deep
- Ideal for repairing interior and exterior concrete surfaces
- Environmentally friendly, water-based formula

PRODUCT #	DESCRIPTION	WEIGHT	PRICE
M1350G	1 - Gallon Pail	17 lbs.	\$ 22.99

**MIXING PROCEDURES:** Use as is. Do not dilute. Stir thoroughly before applying.

**MATERIAL REQUIREMENTS (coverage):** One gallon of Concrete Patch will fill approximately 75-150 feet of cracks depending on depth and width of crack. When used to patch low spots, coverage will vary with depth of patch.

## CONCRETE PATCH BINDER

LIQUID ACRYLIC BINDING AGENT FOR SAND AND CEMENT MIXES

**Features:**

- 100% acrylic emulsion designed for mixing with cement powder and sand
- Produces a patch mix with superior flexural, adhesive, and impact strength
- Excellent adhesion to concrete and masonry
- Resistance to many industrial chemicals
- Environmentally friendly, water-based formulation
- Provides lasting repair for concrete surfaces
- Ideal for thin overlays and repairs up to 1/2" thick

PRODUCT #	DESCRIPTION	WEIGHT	PRICE
M1340P	5 - Gallon Pail	47 lbs.	\$ 119.99
M1340D	55 - Gallon Drum	525 lbs.	\$ 1,236.99

**MIXING PROCEDURES:**

Concrete Patch Binder..... 3.5 gallons  
 Sand.....100 lbs.  
 Portland Cement.....15 - 20 lbs.  
 Water .....5 gallon

(Additional water may be required to achieve workability)

**MATERIAL REQUIREMENTS:** One gallon of Concrete Patch Binder will produce enough patch mix [when mixed with sand and cement] to fill .86 square yard [approximately 7.75 sq. ft.] at 1/4" depth.

## CONCRETE CRACK SEALANT

100% ACRYLIC EMULSION CRACK SEALANT

**Features:**

- Designed for filling cracks in concrete surfaces
- Environmentally friendly 100% acrylic, water-based emulsion
- Outstanding flexibility - remains flexible at temperatures below 0°F
- High solids formula for less shrinkage
- Packaged in one gallon jugs

PRODUCT #	DESCRIPTION	WEIGHT	PRICE
M1355G	1 - Gallon Jug	15 lbs.	\$ 30.99

**MIXING PROCEDURES:** Use as is. Do not dilute.

**MATERIAL REQUIREMENTS (coverage):** Typically, one gallon of Concrete Crack Sealant will fill approximately 75-150 feet of cracks.

**ENVIRONMENTALLY  
FRIENDLY ACRYLIC  
COPOLYMER EMULSION  
DESIGNED FOR DUST  
SUPPRESSION AND SOIL  
STABILIZATION**

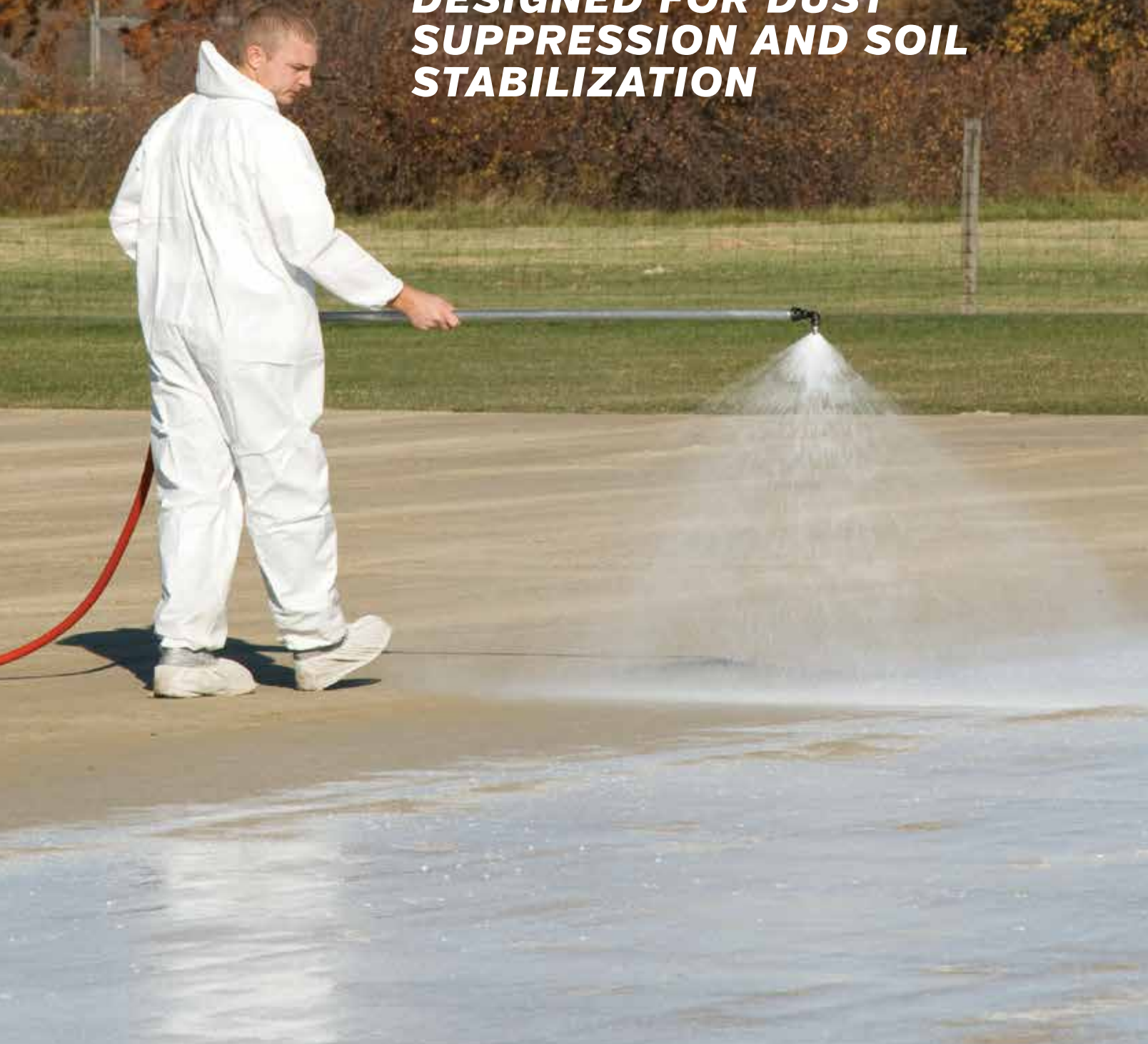

**DUST SUPPRESSANT**



TR575 SPRAYMASTER WITH PRO-AIR SYSTEM PAGE 50



 DUST SUPPRESSANT CAN ALSO BE PIGMENTED FOR COLORIZED APPLICATIONS. [PIGMENT SOLD SEPARATELY]

## DUST SUPPRESSANT AND SOIL STABILIZER

SYNTHETIC POLYMER EMULSION

THE ENVIRONMENTALLY FRIENDLY, NON-TOXIC SYNTHETIC POLYMER EMULSION

SealMaster® Dust Suppressant and Soil Stabilizer is a synthetic polymer emulsion concentrate consisting of a combination of carefully selected polymers designed specifically for dust palliative and soil stabilization applications. Provides superior bonding and stabilizing for lasting performance. It is safe, non-toxic and environmentally friendly.

### Dust Suppressant and Soil Stabilizer Uses:

- Hydroseed and Mulch Tackifier
- Slope Erosion Control
- Stock Pile Sealant and Dust Cap
- Unpaved Road Stabilizer
- ADA Trails and Cart Paths
- Agricultural Roads
- Walking Path & Trail Stabilizer
- Military Operations
- Quarries and Gravel Roads
- Construction Sites
- Gravel Parking Lot Stabilizer
- Heavy Haul Roads
- Helicopter & Aircraft Runway Stabilizer
- Sub-base Stabilizer - Mixed up to 6-inches Deep
- Dust Control and Palliative for Both Traffic and Non-traffic Applications

PRODUCT #	DESCRIPTION	WEIGHT	PRICE
S4000D	55 - Gallon Drum	535 lbs.	\$ 694.99
S4000T	275 - Gallon Tote	2,700 lbs.	\$ 3,481.99
S4000B	Bulk	-	- quoted -



TR 300 SANDPUP TRAILER  
AVAILABLE ON PAGE 54



# BUILD YOUR BUSINESS WITH THE EQUIPMENT THAT HELPED BUILD AN INDUSTRY

LEGENDARY QUALITY • LEGENDARY DURABILITY

ZERO DOWN FINANCING FOR QUALIFIED BUYERS



Backed by the Industry's Largest Dealer Network

**EQUIPMENT**



Shown with water option

## SP 300 SQUEEGEE MACHINE

THE "WORKHORSE" OF SQUEEGEE MACHINES WITH A 320 GALLON CAPACITY

**DESIGNED TO MIX AND APPLY PAVEMENT SEALERS WITH OR WITHOUT SAND**

### SP 300 Features:

- Round tank design with true full-sweep agitation and rubber wiper blades
- Quick change floating squeegee assembly with rear-angling squeegee (windrow feature) and front box squeegee
- Rear wheel drive for added traction and easier trailer loading
- Power steering for ease of maneuvering
- Easy-open, butterfly sealer discharge valves
- Diesel engine optional [21.6 HP Kubota]
- Emergency brake



PRODUCT #	DESCRIPTION	WEIGHT
E1020	SP 300	3,320 lbs.
E9000	Blocking / Bracing Charge	400 lbs.
<b>Options:</b>		
P50335	Diesel Engine	
P50402	28 Gallon Water System	

\* Call for pricing

### SPECIFICATIONS:

Height .....	65"
Width.....	63"
Length.....	140"
Wheel Base.....	60"
Squeegee width.....	93"
Weight.....	3,320 lbs.
Material Tank Capacity .....	320 gallons
Water Tank Capacity Option .....	28 gallons
Engine.....	GX660 Honda

### STANDARD FEATURES:



User-Friendly Control Panel



Hydraulic Shift for Angling the Squeegee



Rear Wheel Direct-Drive



Power Steering



Dual Easy-Open Butterfly Sealer Discharge Valves



Shown with water option

## SP 300 DUAL SPRAY / SQUEEGEE MACHINE

A 320-GALLON CAPACITY MACHINE THAT DOES IT ALL - SPRAY BAR, SPRAY WAND, AND SQUEEGEE APPLICATION

Shown with hydraulic spraybar option

**DESIGNED TO MIX AND APPLY PAVEMENT SEALERS WITH OR WITHOUT SAND**

**SP 300 DUAL™ Features:**

- Kubota gasoline engine
- SandPumper II 2" material pump. Shifts to neutral when wand or spray bar is shut off
- Round tank design with true, full-sweep agitation and rubber wiper blades
- 75-foot hose and spray wand
- Rear wheel direct drive
- Power steering for ease of maneuvering
- Quick change floating squeegee assembly with rear-angling squeegee (windrow feature) and front box squeegee
- Emergency brake



PRODUCT #	DESCRIPTION	WEIGHT
E1000	SP 300 Dual	3,880 lbs.
E9000	Blocking / Bracing Charge	400 lbs.
<b>Options:</b>		
P50402	28 Gallon Water System	
P50246D	Hydraulically Activated Spray bar	

\* Call for pricing

**SPECIFICATIONS:**

Height .....	65"
Width.....	63"
Length.....	140"
Wheel Base.....	60"
Squeegee width.....	93"
Spray width.....	108"
Weight.....	3,880 lbs.
Material Tank Capacity .....	320 gallons
Water Tank Capacity Option .....	28 gallons
Engine.....	49 HP Kubota gasoline
Steering.....	Power
Drivetrain .....	Hydrostat Direct Drive

**STANDARD FEATURES:**



Rear Wheel Direct-Drive



Power Steering



Hydraulic Shift for Angling the Squeegee



User-Friendly Control Panel



Hydraulically Driven Dual Diaphragm Material Pump

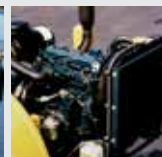

Gasoline Engine Standard



Dual Easy-Open Butterfly Sealer Discharge Valves



1-Gallon Basket Strainer Reduces Tip Clogging



Shown with water option

## SP 575 SQUEEGEE MACHINE

THE "TITAN" OF SQUEEGEE MACHINES  
WITH A 575-GALLON CAPACITY

**DESIGNED TO MIX AND APPLY PAVEMENT  
SEALERS WITH OR WITHOUT SAND**

### SP 575 Features:

- Round tank design with true, full-sweep agitation and rubber wiper blades
- Quick change floating squeegee assembly with rear-angling squeegee (windrow feature) and front box squeegee
- All wheel drive for added traction and easier trailer loading
- Power steering for ease of maneuvering
- Easy-open butterfly sealer discharge valves
- Emergency brake

PRODUCT #	DESCRIPTION	WEIGHT
E1015	SP 575	4,280 lbs.
E9000	Blocking / Bracing Charge	400 lbs.
<b>Options:</b>		
P50402	28 Gallon Water System	

\* Call for pricing



### SPECIFICATIONS:

Height .....	74"
Width .....	65"
Length .....	14'
Wheel Base .....	60"
Squeegee width .....	104"
Weight .....	4,280 lbs.
Material Tank Capacity .....	575 gallons
Water Tank Capacity Option .....	28 gallons
Engine .....	49 HP Kubota gasoline

### STANDARD FEATURES:

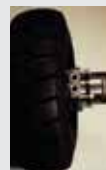

User-Friendly Control Panel

Hydraulic Shift for Angling  
the SqueegeeRear Wheel  
Direct-Drive

Power Steering

Dual Easy-Open Butterfly  
Sealer Discharge Valves





Shown with water option



## SP 575 DUAL SPRAY / SQUEEGEE MACHINE

A 575-GALLON CAPACITY MACHINE THAT DOES IT ALL - SPRAY BAR, SPRAY WAND, AND SQUEEGEE APPLICATION

**DESIGNED TO MIX AND APPLY PAVEMENT SEALERS WITH OR WITHOUT SAND**

### SP 575 Dual Features:

- Round tank design with true, full-sweep agitation and rubber wiper blades
- SandPumper II 2" material pump. Shifts to neutral when wand or spray bar is shut off
- Quick change floating squeegee assembly with rear-angling squeegee (windrow feature) and front box squeegee
- All wheel drive for added traction and easier trailer loading
- Spray bar, spray wand
- Power steering for ease of maneuvering
- Easy-open, butterfly sealer discharge valves
- Emergency brake

### SPECIFICATIONS:

Height .....	74"
Width .....	65"
Length .....	14'
Wheel Base .....	60"
Squeegee width .....	104"
Weight .....	4,760 lbs.
Material Tank Capacity .....	575 gallons
Water Tank Capacity Option .....	28 gallons
Engine .....	49 HP Kubota gasoline

PRODUCT #	DESCRIPTION	WEIGHT
E1005	SP 575 Dual	4,760 lbs.
E9000	Blocking / Bracing Charge	400 lbs.
<b>Optional Features:</b>		
P50402	28 Gallon Water System	
P50246D	Hydraulically Activated Spraybar	

\* Call for pricing

### STANDARD FEATURES:



Rear Wheel Direct-Drive

Power Steering

Hydraulic Shift for Angling the Squeegee

User-Friendly Control Panel

Hydraulically Driven Dual Diaphragm Material Pump

Gasoline Engine Standard

Dual Easy-Open Butterfly Sealer Discharge Valves

1-Gallon Basket Strainer Reduces Tip Clogging



Shown with  
storage deck

## TR 1000 SPRAYMASTER™ WITH PRO-AIR SYSTEM

A 1,000-GALLON TRAILER MOUNTED  
SEALCOAT SPRAY SYSTEM APPLICATOR

**DESIGNED TO MIX AND APPLY PAVEMENT  
SEALERS WITH OR WITHOUT SAND.**

### TR 1000 Features:

- Dependable, low-maintenance, air-driven dual diaphragm pump. Shifts to neutral automatically when wand or spray bar is shut off. Sprays sand-filled pavement sealers.
- 1,000-gallon tank with hydraulically controlled full sweep agitator with rubber wiper blades
- 75-foot hose and spray wand - Spray bar is optional
- Two 8,000 lb. axles, load range G tires
- Running lights and brake lights
- Safety break-away braking system
- One gallon basket strainer



### STANDARD FEATURES:



GX390 HP  
Honda Engine



Dual Diaphragm  
Material Pump



One Gallon Basket  
Strainer



Safety Break-Away  
Braking System

PRODUCT #	DESCRIPTION	WEIGHT
E1140	TR 1000 Pro-Air	4,200 lbs.
E1140XD	TR 1000 Pro-Air Extended Deck	4,560 lbs.
<b>Optional Features:</b>		
P50330	50 Gallon water tank, mounting kit and pump	
P50246M	Manual spray bar (includes seat and mounting components)	
P50247L	Lever - Manual spray bar	
P50331	Hydraulically driven SandPumper II material pump system	
P50246D	Hydraulically operated spray bar (SandPumper II only)	
P50280B	Water Cooler	
P50281B	Night Work Lights	
P50336	Electric Hose Reel: returns spray hose automatically	
P50337	Hand Operated Hose Reel	
T1145	Brush Water Box 40"	
P50405	2" Air Diaphragm Pump	
E9000	Blocking / Bracing Charge (if required)	400 lbs.

\* Call for pricing

### SPECIFICATIONS:

Height .....7' 10"  
 Width .....80"  
 Length with Spray Bar .....18'  
 Length With Optional Storage Deck .....20'  
 Spray Bar Width .....88"  
 Axles .....2 - 8,000 lbs.  
 Tongue Weight Empty .....640 lbs.  
 Engine .....GX390 Honda  
 Material Pump:  
 Type .....Dual Diaphragm  
 Inlet / Outlet .....1 1/2"  
 Air Compressor:  
 Engine .....GX390 Honda  
 SCFM .....30.0



## TR 575 & 750 SPRAYMASTER™ WITH PRO-AIR SYSTEM

TRAILER MOUNTED SEALCOAT SPRAY SYSTEM APPLICATORS

**DESIGNED TO MIX AND APPLY PAVEMENT SEALER WITH OR WITHOUT SAND**

### TR 575 & 750 Features:

- Dependable, low-maintenance air-driven dual diaphragm pump. Shifts to neutral automatically when wand or spray bar is shut off. Sprays sand-filled pavement sealers.
- 575 or 750-gallon tank with hydraulically controlled, full-sweep agitator with rubber wiper blades
- 75-foot hose and spray wand - Spray bar is optional
- Two 6,000 lb. axles
- Running lights and brake lights
- Safety break-away braking system
- One-gallon basket strainer



PRODUCT #	DESCRIPTION	WEIGHT
E1120	TR 575 Pro-Air	3,100 lbs.
E1120XD	TR 575 Pro-Air Extended Deck	3,900 lbs.
E1132	TR 750 Pro-Air	3,900 lbs.
E1132XD	TR 750 Pro-Air Extended Deck	4,200 lbs.

### Optional Features:

P50246M	Manual spray bar [includes seat and mounting components]	
P50247L	Lever - Manual spray bar	
P50330	50 Gallon water tank, mounting kit and pump	
P50331	Hydraulically driven SandPumper II material pump system	
P50246D	Hydraulically operated spray bar [SandPumper II only]	
P50280B	Water Cooler	
P50281B	Night Work Lights	
P50336	Electric Hose Reel: returns spray hose automatically	
P50337	Hand Operated Hose Reel	
T1145	Brush Water Box 40"	
P50405	2" Air Diaphragm Pump	
E9000	Blocking / Bracing Charge (if required)	400 lbs.

### TR 575 SPECIFICATIONS:

Height .....	73"
Width .....	75"
Length with Spray Bar .....	18'
Length with Storage Deck .....	20'
Spray Bar Width .....	88"
Axles .....	2 - 6,000 lbs.
Tongue Weight Empty .....	380 lbs.
Engine .....	GX390 Honda
Material Pump:	
Type .....	Dual Diaphragm
Inlet / Outlet .....	1 1/2"
Air Compressor:	
Engine .....	GX390 Honda
SCFM .....	30.0

### TR 750 SPECIFICATIONS:

Height .....	81"
Width .....	75"
Length with Spray Bar .....	18'
Length with Storage Deck .....	20'
Spray Bar Width .....	88"
Axles .....	2 - 6,000 lbs.
Tongue Weight Empty .....	390 lbs.
Engine .....	GX390 Honda
Material Pump:	
Type .....	Dual Diaphragm
Inlet / Outlet .....	1 1/2"
Air Compressor:	
Engine .....	GX390 Honda
SCFM .....	30.0

\* Call for pricing

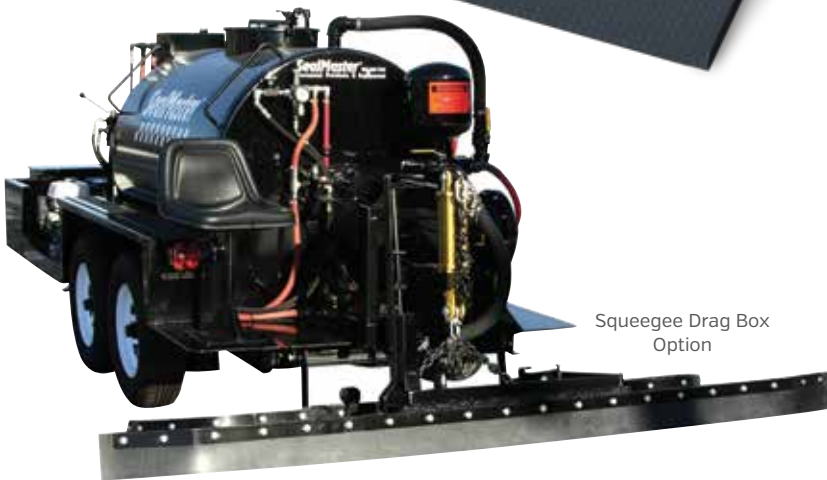
Storage Deck  
ShownSqueegee Drag Box  
OptionSpray Bar and Seat  
Option

## OPTIONAL FEATURES:

- Storage Deck
- Hand Operated Hose Reel
- 50-Gallon Water Tank
- Brush Water Box
- Manually Operated Spray Bar
- Hydraulically Operated Spray Bar [SandPumper II System Only]
- SandPumper II Hydraulically Driven Material Pump System
- Work Lights
- Squeegee Drag Box [Contact SealMaster for More Information]
- Water Cooler
- Maxi Air System

STANDARD  
FEATURES:GX390  
Honda EngineDual Diaphragm  
Material PumpOne Gallon Basket  
StrainerSafety Break-Away  
Braking SystemDirect-Drive  
FWD/REV Agitation



## SPRAYMASTER™ TANKS WITH PRO-AIR SYSTEM

SKID-MOUNTED SEALCOAT SPRAY SYSTEM APPLICATORS

**DESIGNED TO MIX AND APPLY PAVEMENT SEALER WITH OR WITHOUT SAND**

### SprayMaster Features:

- Dependable, low-maintenance, air-driven dual diaphragm pump. Shifts to neutral automatically when wand or spray bar is shut off. Sprays sand-filled pavement sealers.
- Hydraulically controlled, full-sweep agitation with rubber wiper blades
- 75-foot hose and spray wand

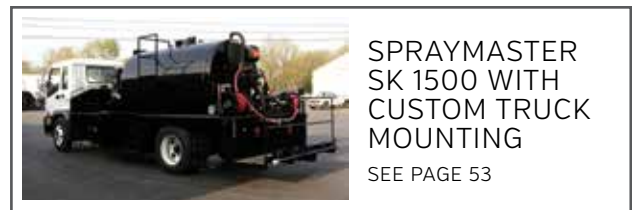

SPRAYMASTER SK 1500 WITH CUSTOM TRUCK MOUNTING  
SEE PAGE 53

### STANDARD FEATURES:



GX390 Honda Engine



Dual Diaphragm Material Pump



One Gallon Basket Strainer



75-foot Hose and Spray Wand

PRODUCT #	DESCRIPTION	WEIGHT
E1320	SK 575 Pro-Air	2,240 lbs.
E1330	SK 750 Pro-Air	2,340 lbs.
E1340	SK 1,000 Pro-Air	3,200 lbs.
E1360	SK 1,500 Pro-Air	3,700 lbs.
E1370	SK 2,000 Pro-Air	4,200 lbs.

### Optional Features:

P50330	50 Gallon water tank, mounting kit and pump	
P50246M	Manual spray bar (includes seat and mounting components)	
P50247L	Lever - Manual spray bar	
P50331	Hydraulically driven SandPumper™ II material pump system	
P50246D	Hydraulically operated spray bar (SandPumper II only)	
P50336	Electric Hose Reel: returns spray hose automatically	
P50337	Hand Operated Hose Reel	
P50403	Maxx-Air 2" Diaphragm Pump with 20 HP Compressor	
P50405	2" Air Diaphragm Pump	
E9000	Blocking / Bracing Charge (if required)	400 lbs.

### SPECIFICATIONS:

Material Pump:  
 Type ..... Dual Diaphragm  
 Inlet / Outlet ..... 1 1/2"  
 Air Compressor:  
 Engine ..... GX390 Honda  
 SCFM ..... 30.0

	575	750	1000	1500	2000
Height	60"	68"	76"	76"	76"
Width	48"	56"	64"	64"	64"
Length	144"	144"	144"	174"	204"

\* Call for pricing



## CUSTOM TRUCK MOUNTING

TRUCK MOUNTED SPRAYMASTER™ TANKS  
FROM 575 TO 2000 GALLON CAPACITIES

**DESIGNED TO MIX AND APPLY PAVEMENT  
SEALER WITH OR WITHOUT SAND**

Custom Truck Mounting begins with the selection of a SprayMaster™ Tank with one of the following material pump systems:

- Pro-Air System [1 1/2" discharge material pump]
- Maxx-Air System [2" discharge material pump]
- SandPumper™ II Hydraulic System [2" discharge material pump]

PRODUCT #	DESCRIPTION
E4100	Custom Mounting: Consists of fabricating a flatbed with fenders onto a truck chassis. The SprayMaster unit is custom mounted to flatbed.
<b>Optional Features:</b>	
E4140	Tool Box: Metal tool box with door and latch. Can be fabricated onto both sides of truck for added storage
P50246D	Hydraulic Spray Bar Kit: Recommended for SandPumper™ II units only. 10 ft. spray width - [Cab operated]
P50246A	Air Operated Spray Bar: For air systems only. 10 ft. spray width [Cab operated]
P50246M	Manual Spray Bar: Recommended for Maxx-Air System, Standard Air System, and SandPumper II units. 10 ft. spray width
P50247L	Lever - Manual spray bar
E4160	8' Squeegee Drag Box Assembly
E4180	10' Squeegee Drag Box Assembly
E4170	Liquid Road Extendable Drag Box
E4200	Rear Operator Platform: Strongly recommended for use with a spray bar
P50336	Electric Hose Reel: Returns spray hose automatically
P50337	Hand Operated Hose Reel
E4240	Reese Style Tube Hitch: Includes pintle eye and 2" ball hitch

\* Call for pricing



## LIQUID ROAD EXTENDABLE DRAG BOX

Designed for heavy bodied sealants with large amounts of aggregate. It extends hydraulically from its closed position of 8' to a maximum of 12' wide. The screed is a combination of squeegee rubbers and brushes. Included with the screed is a truck mounting bracket, hydraulic lift cylinder, and a hydraulic control valve.

### TRUCK MOUNT SIZES:

TANK SIZE [gallons]	PAYLOAD [pounds]	CAB TO AXLE	
		minimum	preferred
575	10,000	85"	90"
750	13,000	85"	90"
1,000	17,000	85"	90"
1,500	24,000	126"	131"
2,000	32,000	156"	161"

\* Payload - Not to be confused with Gross Vehicle Weight (GVW)



**SANDPUP™ TR 300**  
300-GALLON UNIT WITH  
STANDARD HYDRAULIC AGITATION

# SEALMASTER™ SANDPUP™ TRAILER & SKID UNIT

PERFORMANCE & ECONOMY

**SANDPUP™ SK 300**  
300-GALLON UNIT



## SANDPUP™ TRAILER & SKID UNIT

THE ECONOMICAL WAY TO  
TRANSPORT AND APPLY PAVEMENT  
SEALERS WITH SAND

**DESIGNED TO MIX AND APPLY PAVEMENT  
SEALER WITH OR WITHOUT SAND**

### SandPup Trailer & Skid Unit Features:

- Air Driven Dual Diaphragm Pump with Basket Strainer
- Hide-Away Spray Wand Holder (trailer unit only)
- Hose Reel with 75-Foot Hose
- Safety Break-Away Braking System (trailer unit only)
- Hand Agitated on SK300 model

PRODUCT #	DESCRIPTION	WEIGHT
E1160	SandPup TR 300 Tank Trailer	1,920 lbs.
E1380	SandPup Skid Tank - Fits 8-foot beds only. Check weight capacity of your truck. The tank is mounted sideways and sits forward of the truck axle.	1,400 lbs.
<b>Optional Features:</b>		
P50340	Hydraulic Agitation for SandPup SK 300	
T1145	Brush Water Box 40"	
P50402B	14-Gallon Poly Water Tank	

\* Call for pricing

### OPTIONAL FEATURES:



Brush / Squeegee  
Water Box



Hydraulically Driven Full  
Sweep Agitation

### SPECIFICATIONS:

	TR 300	SK 300
Height	68"	52"
Width	67"	57"
Length	156"	85"

### STANDARD FEATURES:



Hose Reel with  
75-foot Hose



Hide-Away Spray  
Wand Holder  
(SandPup Trailer)



Air Driven Dual Diaphragm  
Pump with Basket Strainer



Safety Break-Away  
Braking System  
(SandPup Trailer)

## SANDPUP™ II

The SandPup's™ bigger, tougher brother. A larger air compressor and material pump provides maximum performance.

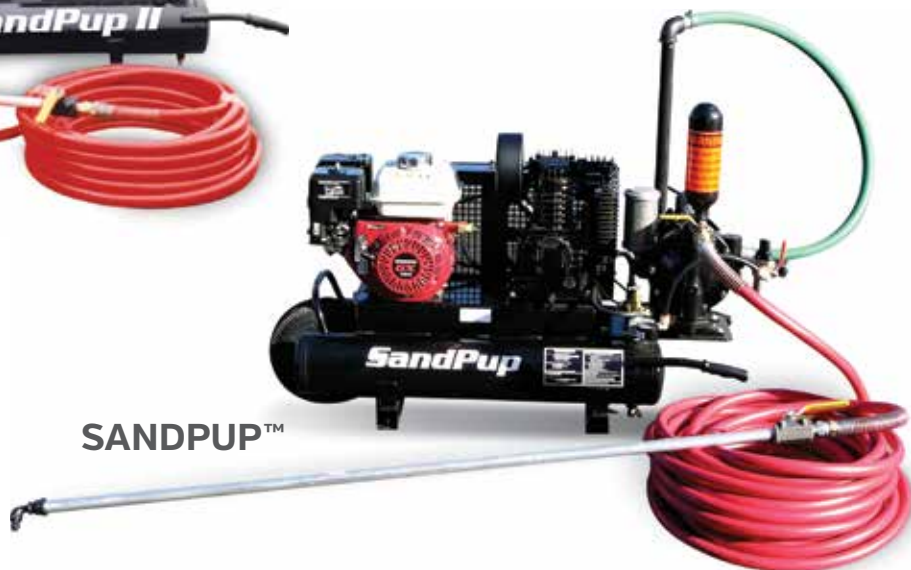

## SANDPUP™ PORTABLE SPRAY SYSTEM

THE PORTABLE SOLUTION FOR SPRAYING PAVEMENT SEALERS WITH SAND

**ALSO IDEAL FOR APPLYING COLD POUR CRACK SEALANTS AND WATER BASE TACK COAT**

### SandPup Features:

- Air-driven, dual diaphragm pump (SandPup - 1" discharge, SandPup II - 1 1/2" discharge)
- 75-foot spray hose and wand
- Basket Strainer reduces tip clogging
- Engine - SandPup - GX160 Honda  
- SandPup II - GX270 Honda

PRODUCT #	DESCRIPTION	WEIGHT
E1620	SandPup - GX160 Honda engine	220 lbs.
E1630	SandPup II - GX270 Honda engine	440 lbs.
<b>Optional Features:</b>		
P50343	SandPup Crack Filler Wand Kit	
P50342	SandPup II Crack Cleaning Wand Kit	

\* Call for pricing

### SANDPUP SPECIFICATIONS:

Height .....	33"
Width .....	22"
Length .....	41"
Weight .....	220 lbs.
Engine .....	GX160 Honda
Material Pump:	
Type .....	Air-Operated Dual Diaphragm
Inlet / Outlet .....	1"
Air Compressor:	
SCFM .....	14.6
PSIG .....	125

### SANDPUP II SPECIFICATIONS:

Height .....	50"
Width .....	25"
Length .....	56"
Weight .....	440 lbs.
Engine .....	GX270 Honda
Material Pump:	
Type .....	Air-Operated Dual Diaphragm
Inlet / Outlet .....	1 1/2"
Air Compressor:	
SCFM .....	24
PSIG .....	125

## SANDPUP OPTIONS



### SANDPUP CRACK FILLER WAND KIT

Fits both SandPup I and II. Ideal for applying cold pour crack fillers.

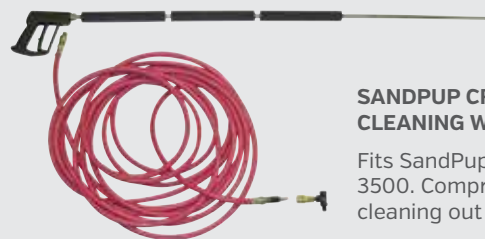

### SANDPUP CRACK CLEANING WAND KIT

Fits SandPup II and Crack Pro 3500. Compressed air jet for cleaning out cracks.





**CRACK PRO® 3500**



**CRACK PRO® 3000**



**CRACK PRO® 2000**

## CRACK PRO® COLD-POUR CRACK FILLER APPLICATION UNITS

FOR EASE, CONVENIENCE & HIGH PRODUCTION

DESIGNED TO PUMP AND APPLY COLD POUR CRACK FILLERS AND SEALANTS FROM PAILS & DRUMS

**All Units Feature:**

- Air Diaphragm Material Pump
- 50 ft. Hose & Wand
- Straight Pipe & Crack Shoe Application Assemblies
- Suction Hose
- Basket Stainer

PRODUCT #	DESCRIPTION	WEIGHT
E1635	Crack Pro 3500	440 lbs.
E1625	Crack Pro 3000	220 lbs.
E1701	Crack Pro 2000	114 lbs.

\* Call for pricing

Economical pump unit that plugs into any air compressor (10 cfm or higher) [Requires separate air compressor].

**SPECIFICATIONS:**

	Crack Pro 3500	Crack Pro 3000	Crack Pro 2000
Length	56"	33"	30"
Width	25"	41"	23"
Height	50"	22"	41"
Weight	440 lbs.	220 lbs.	114 lbs.
SCFM	24	14.6	10
PSIG	125	125	100
Engine	GX270 Honda	GX160 Honda	-

## TEXTURE SPRAY UNIT

IDEAL FOR SPRAYING  
COLORPAVE HD AND OTHER  
TEXTURED COATINGS

### Texture Spray Unit Features:

- G x 120 Honda Engine
- Compressor - 5.1 CFM @ 100 psi
- 1" Air Diaphragm Pump
- 25' Delivery Hose
- Screened Suction Hose Assembly
- Cart Holds Two 5-Gallon Buckets
- Swivel Wheel Steering

### FEATURES:

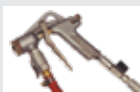

Graco Texture  
Spray Gun

### SPECIFICATIONS:

Height ..... 41"  
Width ..... 32"  
Length ..... 60"



PRODUCT #	DESCRIPTION	WEIGHT
E1702	Texture Spray Unit	200 lbs.

\* Call for pricing

## PORTA-PUMP™

THE PORTABLE MULTI-PURPOSE PUMP SYSTEM  
FOR PAVEMENT SEALERS AND CRACK FILLERS

Use your own compressor! Spray pavement sealers with or without sand. Also can be used for pumping and applying cold-pour crack fillers and sealants. Mounts directly on top of a 55-gallon drum.

[Requires separate air compressor - Minimum of 10 cfm recommended]

**CAN BE MOUNTED DIRECTLY TO TOP OF DRUM  
OR RESTED ON FLAT SURFACE**

### Porta-Pump Features:

- 1" Air Diaphragm Pump
- Basket Strainer
- 75' Spray Hose and Wand
- Suction Hose Assembly

### SPECIFICATIONS:

Width ..... 23"  
Length ..... 30"  
Pressure ..... 100 PSI



PRODUCT #	DESCRIPTION	WEIGHT
E1700	Porta-Pump	114 lbs.

\* Call for pricing

## SEALER WHEELER™

MIX AND APPLY PAVEMENT SEALERS,  
TENNIS COATINGS & MORE

The Sealer Wheeler is an economical mixing and dispensing unit that is ideal for pavement sealers, tennis court coatings, and many other uses.

**DESIGNED TO MIX AND DISPENSE COATINGS  
WITH OR WITHOUT SAND**

### Sealer Wheeler Features:

- Full Sweep Hand Agitator
- 2" Ball Valve Discharge
- Hinged Lid Opening
- Pneumatic Tires



PRODUCT #	DESCRIPTION	WEIGHT
E1070	Sealer Wheeler - 55 Gallon	215 lbs.

\* Call for pricing



## HEATED ASPHALT STORAGE TANKS

IDEAL FOR PAVING GRADE ASPHALTS, ROOFING ASPHALTS & ASPHALT EMULSIONS

**TANKS CAN BE CUSTOMIZED TO MEET SPECIFIC REQUIREMENTS OR SIZES**

### Heated Asphalt Storage Tank Features:

- 1/4" plate steel construction
- 4" thick mineral wool insulation
- Foam glass block insulation on tank bottom
- Ribbed steel panel outer skin (covers insulation)
- Thermostatically controlled electric heat (all voltages and phases available) - Heater coil system also available
- Liquid level scale



Liquid Level Scale



Heater Control

### OPTIONAL FEATURES:



Turbine Agitator



Material Pump

PRODUCT #	DESCRIPTION
E1870	10,000 Gallon
<b>Optional Features:</b>	
P50277B	Material Pump - 80 GPM
P50278B	Propeller Blade Agitation

\* Call for pricing



## MASTERMIX™ BULK STORAGE TANKS

THE ULTIMATE IN SEALER  
CONVENIENCE & ECONOMY

A SealMaster® Bulk Storage Tank enables you to buy pavement sealer in bulk and save. The convenience of on-site storage enables you to spend more time sealcoating and less time driving to refill equipment with sealer.

**AVAILABLE IN 6,000, 8,000, AND 10,000  
GALLON CAPACITIES**

### MasterMix™ Features:

- Hydraulically controlled full sweep agitator
- 2-inch Roper pump
- G x 390 Honda engine
- Clean out port on bottom of tank end

### Options (6,000 - 10,000):

- Three Phase Electric Motor
- Single Phase Electric Motor

PRODUCT #	DESCRIPTION	WEIGHT
E1820	MasterMix 6,000	7,200 lbs.
E1830	MasterMix 8,000	7,950 lbs.
E1840	MasterMix 10,000	8,800 lbs.
<b>Optional Features:</b>		
P941A002	3 Phase Electric Motor	
P941A001	Single Phase Electric Motor	
E1850	Metal Housing Over Pump and Motor	

\* Call for pricing

## MASTERMIX™ EXTREME DUTY BULK STORAGE TANKS

HEAVY DUTY TANK DESIGNED FOR  
MIXING AND STORING SAND-FILLED  
PAVEMENT SEALERS

### MasterMix™ Extreme Duty Features:

- 40 gpm hydraulically driven diaphragm pump system
- Heavy duty agitator shaft with packing gland on drive end
- Multiple paddle agitation system with rubber wipers
- Variable speed control on agitation and pump
- G x 390 Honda engine

PRODUCT #	DESCRIPTION	WEIGHT
E1825	MasterMix Extreme Duty 6,000	7,500 lbs.
E1835	MasterMix Extreme Duty 8,000	8,250 lbs.
E1841	MasterMix Extreme Duty 10,000	9,100 lbs.
<b>Optional Features:</b>		
P50410	90 gpm Hydraulic Driven Diaphragm Pump with 16 HP Vanguard	
P50411	Hydraulic Oil Cooler	
P941A002	3 Phase Electric Motor	
P941A001	Single Phase Electric Motor	
E1850	Metal Housing Over Pump and Motor	

\* Call for pricing

### SPECIFICATIONS:

Tank Size	6,000	8,000	10,000
Height	104"	104"	130"
Width	96"	96"	120"
Length	243"	312"	272"
Weight	7,200 lbs.	7,950 lbs.	8,800 lbs.



**HAND AGITATED  
MIXING TANKS**  
FEATURING  
ECONOMY &  
CONVENIENCE



## HAND-AGITATED MIXING TANKS

AVAILABLE IN 300 AND 575  
GALLON CAPACITIES

**IDEAL FOR MIXING PAVEMENT SEALERS WITH  
OR WITHOUT SAND**

### Hand-Agitated Mixing Tank Features:

- Full sweep agitation
- 2-inch gate valve material discharge
- Skid mounted or trailer mounted
- Storage deck with loading ramp

PRODUCT #	DESCRIPTION	WEIGHT
E2005	Hand-Agitated SK 300 Skid Mount	750 lbs.
E2025	Hand-Agitated SK 575 Skid Mount	950 lbs.
E2006	Hand-Agitated TR 300 Trailer Mount	1,440 lbs.
<b>Optional Features:</b>		
P50340	Hydraulic Agitation	75 lbs.
E9000	Blocking / Bracing Charge (if required)	400 lbs.

\* Call for pricing



**SEALER  
WHEELER  
APPLICATOR**

AVAILABLE  
ON PAGE 57

### SPECIFICATIONS:

	TR 300	SK 300	SK 575
Height	68"	52"	61"
Width	67"	41"	52"
Length	156"	80"	101"
Weight	1,440 lbs.	750 lbs.	950 lbs.



## R-1 AGGREGATE CHIP SPREADER

IDEAL FOR TAR AND CHIP /  
CHIP SEAL APPLICATIONS

The R-1 is a tow-behind aggregate spreader that is ideal for tar and chip operations on roadways. The R-1 distributes aggregate to precise depths with clean-cut edges. It features an open-type spiral agitator to convey material to outer ends of hopper.

**SPREAD WIDTH CAN BE ALTERED WITH  
OPTIONAL 12" AND 24" BLOCK-OFF PLATES**

### R-1 Aggregate Chip Spreader Features:

- Auger control lever
- Material auger
- Feed gate control lever
- Drive wheels
- Hitch height adjustment
- Quick attachment receiving hitch



Shown with optional 10'  
operator platform

PRODUCT #	DESCRIPTION	WEIGHT
E2330	10' spread width, 1.41 cu. yd. capacity	2,420 lbs.
<b>Optional Features:</b>		
PE2380	10' Operator Platform	
PE2460	Truck Hitch - 1 supplied with each spreader	
PE2470	12" Block-Off Plates - to alter width of spread	
PE2480	24" Block-Off Plates - to alter width of spread	
PE2490	Tailgate Hook - [2 required] Two tailgate hooks supplied with each spreader	
E2500	R-1 Trailer System - For towing aggregate spreader	
E9000	Blocking / Bracing Charge (if required)	400 lbs.

\* Call for pricing



## TR 300 HEATED ASPHALT DISTRIBUTOR

HEAT AND SPRAY ASPHALT EMULSIONS, CUTBACKS, REJUVENATORS, PRIMERS, & MORE

### TR 300 Features:

- 300 Gallon capacity
- Electric brakes with safety break-away system
- Easy access basket strainer reduces tip clogging
- Positive displacement material pump
- 5-gallon diesel wash down system
- 300,000 BTU vapor heat system with safety shut-off
- Lock down lid with breather vent
- 50-ft. hose and spray wand
- Requires LP gas cylinder - Not included



PRODUCT #	DESCRIPTION	WEIGHT
E2220	TR 300 - Heated Asphalt Distributor	1,805 lbs.
<b>Options:</b>		
P50246M	Manual Spray Bar (includes seat and mounting components) - 10 ft spray width	
P50247L	Lever - Manual Spray Bar	
P50344	2" Pump - Hydraulic Drive w GX240 Honda	
E9000	Blocking / Bracing Charge [if required]	400 lbs.

\* Call for pricing

### SPECIFICATIONS:

Height .....66"  
 Width.....72"  
 Length.....177"  
 Weight.....1,805 lbs.  
 Tongue Weight Empty ..... 180 lbs.  
 Axle..... 6,000 lbs.  
 Engine.....GX160 Honda  
 Burner System ..... 300,000 BTU vapor heat system with safety shut off  
 Material Pump.....Positive displacement with pressure relief valve 15 GPM

### STANDARD FEATURES:



Electric Brakes with Safety Break-Away System



Easy Access Basket Strainer Reduces Tip Clogging



Positive Displacement Material Pump



5 Gallon Diesel Wash Down System



300,000 BTU Vapor Heat System with Safety Shut-Off



Lock down lid with breather vent



Shown with optional spray bar and seat

## TR 575 HEATED ASPHALT DISTRIBUTOR

HEAT AND SPRAY ASPHALT EMULSIONS, CUTBACKS, REJUVENATORS, PRIMERS, & MORE

### TR 575 Features:

- 575 gallon capacity
- Electric brakes with safety break-away system
- Easy access basket strainer reduces tip clogging
- Positive displacement material pump
- 5-gallon diesel wash down system
- 300,000 BTU vapor heat system with safety shut-off
- Lock down lid with breather vent
- 50-ft. hose and spray wand
- Requires LP gas cylinder - Not included



LP gas cylinder not included

PRODUCT #	DESCRIPTION	WEIGHT
E2260	TR 575 - Heated Asphalt Distributor	3,000 lbs.
<b>Options:</b>		
P50246M	Manual Spray Bar (includes seat and mounting components) - 10 ft spray width	
P50247L	Lever - Manual Spray Bar	
P50344	2" Pump - Hydraulic Drive w GX240 Honda	
E9000	Blocking / Bracing Charge (if required)	400 lbs.

\* Call for pricing

### SPECIFICATIONS:

Height .....	73"
Width .....	75"
Length .....	17'
Weight .....	3,000 lbs.
Tongue Weight Empty .....	300 lbs.
Axle .....	2 - 6,000 lbs.
Engine .....	GX160 Honda
Burner System .....	300,000 BTU vapor heat system with safety shut off
Material Pump .....	Positive displacement with pressure relief valve 15 GPM

### STANDARD FEATURES:



Electric Brakes with Safety Break-Away System



Easy Access Basket Strainer Reduces Tip Clogging



Positive Displacement Material Pump



5 Gallon Diesel Wash Down System



300,000 BTU Vapor Heat System with Safety Shut-Off



Lock down lid with breather vent





Requires LP gas cylinder

## SM-30 DIRECT FIRE MELTER

IDEAL FOR USE WITH  
CRACKMASTER™ SUPREME DIRECT  
FIRE CRACK SEALANT

**SM-30 Features:**

- Burner, hose and regulator
- 30-gallon capacity
- Hand operated agitator
- Retractable carrying handles
- Designed for use with Vapor LP gas cylinder [not included]
- Melting Rate is approximately 1/2 hour

PRODUCT #	DESCRIPTION	WEIGHT
E2800	SM-30 Direct Fire Melter	315 lbs.

\* Call for pricing

**SPECIFICATIONS:**

Height.....	30"
Width.....	23"
Length.....	48"
Weight.....	315 lbs.



## MA-10 MELTER APPLICATOR

IDEAL FOR MELTING AND APPLYING  
CRACKMASTER™ SUPREME  
DIRECT-FIRE CRACK SEALANT

**MA-10 Melter Applicator Features:**

- Burner, hose and regulator
- 10-gallon capacity
- Hand operated agitator
- Designed for use with Vapor LP gas cylinder [not included]
- Melting Rate is less than 1/2 hour

PRODUCT #	DESCRIPTION	WEIGHT
E2820	MA-10 Melter Applicator	129 lbs.

\* Call for pricing

**DIMENSIONS:**

Height.....	39"
Width.....	24"
Length.....	43"

Requires LP gas cylinder



## SM-10 MELTER

IDEAL FOR MELTING CRACKMASTER™ SUPREME DIRECT-FIRE MATERIAL

### SM-10 Melter Applicator Features:

- 10 gallon tank size
- Include burner, hose, and regulator [Designed for use with Vapor LP gas cylinder]

PRODUCT #	DESCRIPTION	WEIGHT
E2830	SM-10 Melter	113 lbs.

\* Call for pricing

### DIMENSIONS:

Height.....	36"
Width.....	18"
Length.....	29"



## P.A. TORCH

CLEANS & DRIES CRACKS

### P.A. Torch Package Includes:

Torch, 50 ft. U.L. rated gas hose, regulator and 1/2" standard air quick connect

PRODUCT #	DESCRIPTION	WEIGHT
T5550	P.A. Torch Package	15 lbs.

\* Call for pricing



[LP tank not included]

## CRACK PRO® TURBO

CLEANS AND DRIES CRACKS IN ONE MOTION. HIGHLY MANEUVERABLE

PRODUCT #	DESCRIPTION	WEIGHT
E1704	Crack Pro® Turbo	280 lbs.

\* Call for pricing

### DIMENSIONS:

Height.....	42"
Width.....	39"
Length.....	62"

## SEALMASTER® HOT AIR LANCE

HIGH VELOCITY HEAT LANCE CLEANS AND DRIES CRACKS QUICKLY

SealMaster® Hot Lance Kit - Recommended for use with 60-100 cfm [50-175 psi] air compressor.

**Heated air temperature:** 400°F to 2600°F.

**Exit heated air:** Up to 1000 ft. per second.

**BTU:** Up to 1,000,000.

**Kit includes:** Hot Air Lance, 50' hose with protective cover, shoulder strap, air filter, LP regulator gauge and quick connect fittings.



PRODUCT #	DESCRIPTION	WEIGHT
T5555	SealMaster® Hot Air Lance Kit	45 lbs.
T5556	Wheel Kit with Debris Guard	8 lbs.

\* Call for pricing

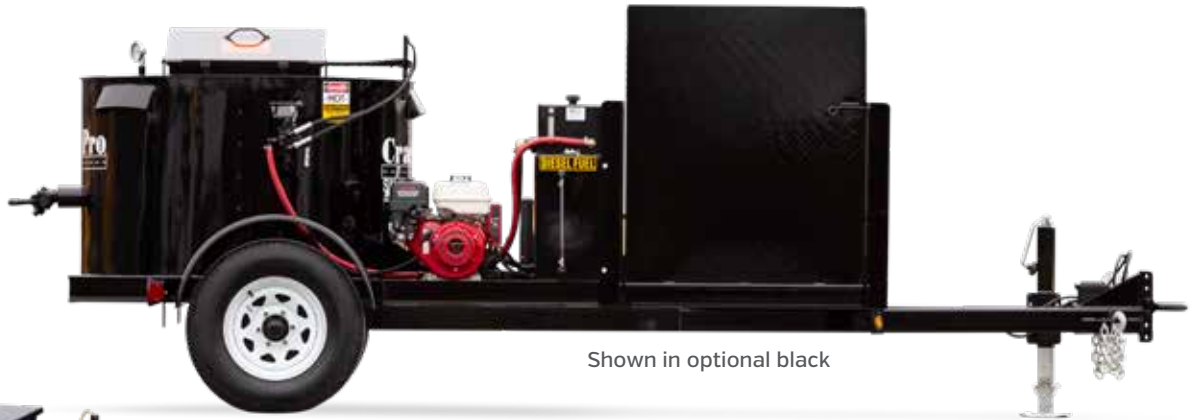

Shown in optional black



# CRACK PRO® SM-125 DIRECT FIRE MELTER

WITH AUTOMATIC  
TEMPERATURE CONTROL

**SM-125 Features:**

- 125 Gallon Capacity
- Trailer Mounted
- Automatic Fuel Shut-Off
- Hydraulically Driven Agitation
- Automatic Temperature Control
- Anti-Splash Loading
- Storage Deck with Loading Ramp

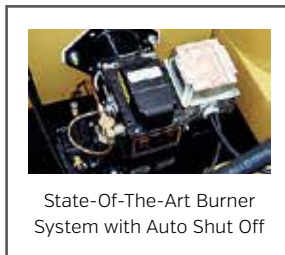

State-Of-The-Art Burner System with Auto Shut Off

**STANDARD FEATURES:**



Anti-Splash Loading



Forward / Reverse Full Sweep Agitation

**SPECIFICATIONS:**

Height .....	66"
Loading Height.....	57"
Width.....	78"
Length.....	136"
Weight.....	2,620 lbs.
Engine.....	GX240 Honda

PRODUCT #	DESCRIPTION	WEIGHT
E2810XD	SM-125 - Diesel Fuel Burner	2,620 lbs.

\* Call for pricing



## CRACK PRO 260 GRAVITY FLOW

2019 model will include storage deck with ramp



## CRACK PRO 125 GRAVITY FLOW

2019 model will include storage deck with ramp

## CRACK PRO® GRAVITY FLOW

OIL-JACKETED MELTER FOR HOT  
POUR CRACK SEALING MATERIALS

### Crack Pro 60, 125 & 260 Gravity Flow Features:

- State-Of-The-Art Burner System with Auto Shut Off
- FWD/REV Hydraulic Agitation
- Direct Drive Hydraulic Agitation
- Anti-Splash Material Loading Hatch
- Oil and Material Temperature Gauges
- Automatic Temperature Control
- Low Profile for Operator Safety



## CRACK PRO 60 GRAVITY FLOW

### CRACK PRO 60 GRAVITY FLOW:

PRODUCT #	DESCRIPTION	WEIGHT
E2730D	Crack Pro 60 - Diesel Fuel Burner	1,500 lbs.

### CRACK PRO 125 GRAVITY FLOW:

PRODUCT #	DESCRIPTION	WEIGHT
E2728D	Crack Pro 125 - Diesel Fuel Burner	2,640 lbs.

### CRACK PRO 260 GRAVITY FLOW:

PRODUCT #	DESCRIPTION	WEIGHT
E2736	Crack Pro 260 - Diesel Fuel Burner	3,640 lbs.

\* Call for pricing

### STANDARD FEATURES:



FWD/REV  
Hydraulic Agitation  
Valve



Direct Drive  
Hydraulic  
Agitation



Anti-Splash  
Material  
Loading Hatch



Oil and Material  
Temperature  
Gauges

### SPECIFICATIONS:

Tank Size	CP 60	CP 125	CP 260
Tank Capacity	60 gallon	125 gallon	260 gallon
Heat Transfer Oil	10 gallons	25 gallons	30 gallons
Max. BTU Input	225,000	225,000	372,000
Construction	Oil Jacket	Oil Jacket	Oil Jacket
Temp. Control	Digital	Digital	Digital
Tank Opening	12" x 14"	12" x 14"	16" x 24"
Insulation	1 1/2" ceramic	1 1/2" ceramic	1 1/2" ceramic
Agitation	Full Sweep Hydraulic	Full Sweep Hydraulic	Full Sweep Hydraulic
Heating System	Diesel burner	Diesel burner	Diesel burner
Power Unit	GX240 Honda	GX240 Honda	GX240 Honda
Suspension	2,500 lb. axle	5,400 lb. axle	6,000 lb. axle
Loading Height	54"	57"	59"
Overall Height	66"	71"	75"
Width	64"	78"	94"
Length	122"	136"	162"
Weight	1,500 lbs.	2,640 lbs.	3,640 lbs.

# CRACK PRO<sup>®</sup> HEATED HOSE MACHINES

OIL-JACKETED MELTER / APPLICATORS  
FOR HOT POUR CRACK SEALING MATERIALS

**ALL DIESEL POWER FOR MAXIMUM EFFICIENCY!**

Both the burner and the engine are powered by diesel fuel for maximum safety, efficiency, and performance.

### Crack Pro Heated Hose Machine Features:

- State-of-the-art heated hose maintains material temperature throughout the application process
- 30% larger heating unit for the industry's fastest heat-up and recovery time
- Digital Control Center with protective cover. Control Center offers AC gauge to monitor heating of electric hose
- Anti-Splash Material Loading Hatch for safer loading of sealant materials
- Insulated with 1.5" ceramic, covered by a 16 gauge steel outer body
- Electro-hydraulic manifold with flow control for pump and mixer speeds
- Liquid Cooled Kubota Diesel Engine
- Diesel fired Beckett Burners are electronically controlled with auto shut off
- Horn button on wand notifies driver to move ahead or back
- Direct-Drive FWD/REV Full Sweep Agitation

### TR 125 & 260 DA Model Features:

- Direct Drive Air Compressor with 100' x 5/8" Reeled Hose & Wand
- V1505 Kubota Diesel Engine

PRODUCT #	DESCRIPTION	WEIGHT
E2745HH	TR 125 D	3,700 lbs.
E2747HH	TR 125 DA	4,000 lbs.
E2755HH	TR 260 D	5,000 lbs.
E2765HH	TR 260 DA	5,300 lbs.
P74001	Upgrade to a 22' hose	

*See page 70 for available options*

\* Call for pricing

## SAFETY INNOVATION...



The industry's lowest profile machines for better operator view of traffic and surrounding work area.

### SPECIFICATIONS:

Tank Capacity .....	125, 260 gallons
Heat Transfer Oil.....	25, 30 gallon capacity
Maximum BTU Input .....	372,000 BTU
Construction .....	Oil jacket type tank
Temperature Control.....	Automatic Electronic
Tank Opening.....	16" x 24" no splash material loading
Insulation .....	1 1/2" High Temperature Ceramic
Agitation.....	Full Sweep, Hydraulically Driven, Forward / Reverse
Material Pump.....	2" Steel Gear, Reversible
Heating System .....	Bottom fired forced air diesel fuel
Suspension.....	Torsion type axle with 5 lug tubeless tire
Application Hose .....	3/4" x 18' electric hose [22' available]
Heated Hose .....	Eliminates need to flush out hose for cleanup

	CP 125	CP 260
Loading Height	54"	48"
Overall Height	80"	90"
Width	78"	93"
Length	192"	206"
Empty Weight	3,700 lbs.	5,000 lbs.
Empty Weight with conveyor	4,200 lbs.	5,500 lbs.
Height with conveyor	8' 6"	8' 6"

STANDARD FEATURES ON ALL "D" AND "DA" MODELS:



Digital Control Center with protective cover



Anti-Splash Material Loading Hatch



Electro-hydraulic manifold



Liquid Cooled Kubota Diesel Engine Standard



Horn button on wand

## CP-125 HEATED HOSE MACHINE



Ready to apply within 1 hour

## CP-260 HEATED HOSE MACHINE



Shown with optional LP tank stand



Side mounted burner for easy maintenance



Steel enclosure for the control box



Ergonomic counter balanced hose boom

NEW FEATURES IN 2019!



Diesel fired Beckett Burner



Direct-Drive FWD/REV Full Sweep Agitation

STANDARD FEATURES ON ALL "DA" MODELS:



Direct Drive Air Compressor



100' x 5/8" Reeled Hose & Wand



V1505 Kubota Diesel Engine

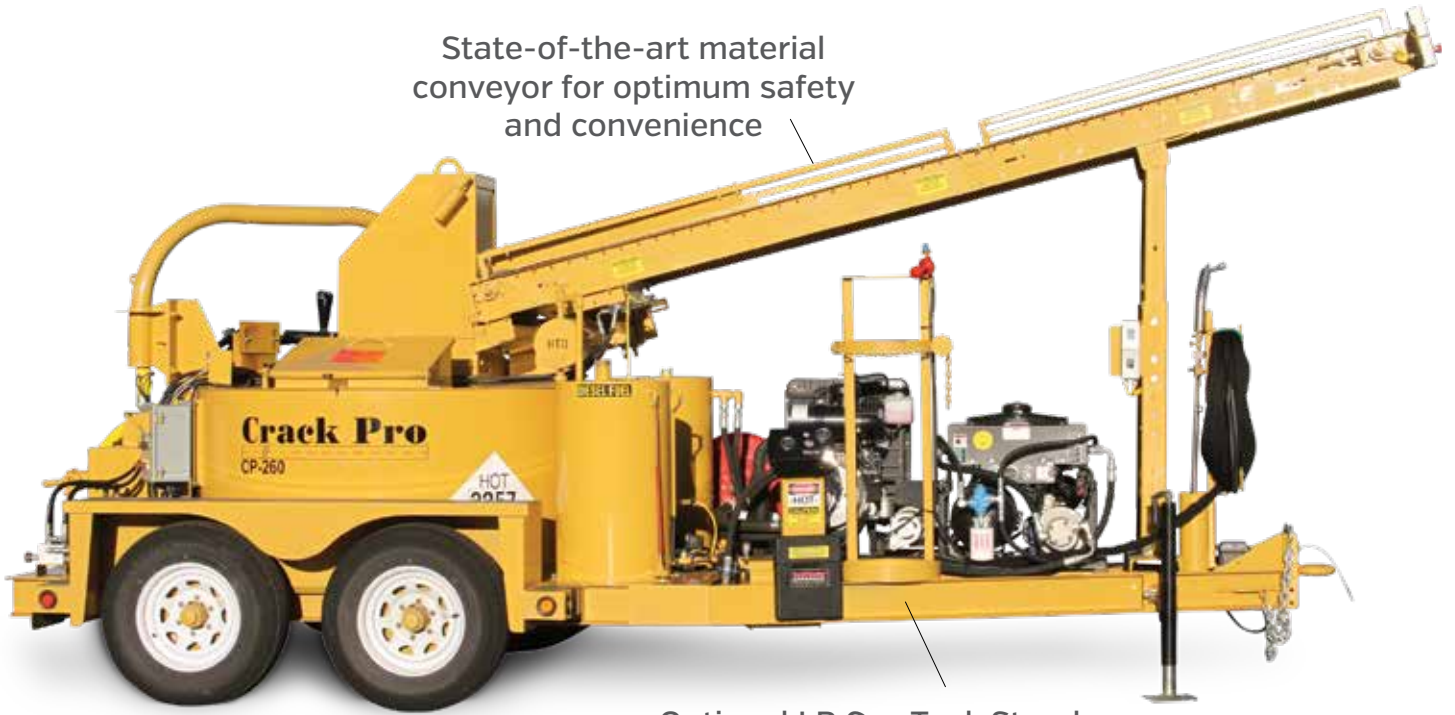

State-of-the-art material conveyor for optimum safety and convenience

Optional LP Gas Tank Stand



Arrowboard



Engine Security Cover

## CRACK PRO® MELTER / APPLICATOR OPTIONS

PRODUCT #	DESCRIPTION	WEIGHT
<i>Options:</i>		
P552A001	Material Block Conveyor	
E2680	Hydraulic surge brake assembly	
P553A008	2 5/16" ball hitch	
P516A021	Arrowboard	
P447A001	Fire extinguisher	10 lbs.
P163A004	1/8" or 1/4" wand tip	
P74000B231	Engine security cover CP Non-Air Machines	
P74000D231	Engine security cover DA Machines	
P163A005	Sealing shoe	
P163A012	Crack sealing square	
P74000B004	Tool box	
P74002	LP tank stand	



Tool Box

\* Call for pricing

**SealMaster®**

# MAINTAINING THE WORLD'S PAVEMENT

**CRACK PRO MELTER/APPLICATORS HAVE  
REVOLUTIONIZED THE CRACK FILLING INDUSTRY**

- The Industry's Fastest Material Heating Time
- State-of-the-Art Safety Innovations Including the Industry's Lowest Profile Design - Provides Maximum Operator Safety

**ZERO DOWN FINANCING FOR QUALIFIED BUYERS**



**Backed by Our Nationwide Dealer Network**



# LITTLE WONDER®



## C5 BLOWER

IDEAL FOR REMOVING DIRT AND DEBRIS FROM PAVEMENT SURFACES

### C5 Blower Features:

- Large flat-free wheels
- Adjustable Aim-rite nozzle
- Padded fold-down handle
- Steel front-wheel mounting bracket
- Kohler SH265 (196cc)
- Lightweight and more powerful than backpack blowers

PRODUCT #	DESCRIPTION	WEIGHT
T6009	C5 Blower Kohler SH 265 (196cc)	108 lbs.

\* Call for pricing



## PRO CRACK CLEANER

IDEAL FOR CLEANING DIRT, DEBRIS, AND VEGETATION FROM PAVEMENT CRACKS PRIOR TO CRACK SEALING

### Pro Crack Cleaner Features:

- Adjustable front wheels
- Long lasting wire wheel, heavy duty 9" wire wheel
- 4 HP Honda Engine
- Lightweight and low center of gravity, increases maneuverability and makes it easy to load and unload

PRODUCT #	DESCRIPTION	WEIGHT
T6305	Pro Crack Cleaner, 4 HP Honda GX120, attachment with 9" wire brush	77 lbs.
P150A002	9" replacement brush	6 lbs.

\* Call for pricing



## OPTIMAX BLOWER

AVAILABLE IN SEVERAL ENGINE OPTIONS

### Optimax Blower Features:

- All steel housing and fans
- Tougher handles, new transport bracket, integrated front discharge
- 5 year warranty

PRODUCT #	DESCRIPTION	WEIGHT
T6006	160 CC Honda GC 160	123 lbs.
T6046	277 CC Kohler Command PRO CH 395	174 lbs.
T6050	270 CC Honda GX 270	156 lbs.
T6060	390 CC Honda GX 390	181 lbs.
T6070	570 CC Vanguard VG 570	192 lbs.
P151A069	Swivel Wheel Kit - Fits any Little Wonder high output blower except T6009 & T6070	14 lbs.

\* Call for pricing



## BILLY GOAT GRAZOR

AN INDUSTRY FAVORITE FOR CLEANING CRACKS PRIOR TO CRACKSEALING

### Billy Goat Grazor Features:

- 8" twisted wire brush and 4 HP Honda GX 120 engine

PRODUCT #	DESCRIPTION	WEIGHT
T6370	Billy Goat Grazor	91 lbs.
P153A096	8" replacement brush	6 lbs.

\* Call for pricing



## FORCE BLOWER

SPECIAL DESIGN FOR MAXIMUM AIR MOVEMENT AND MINIMAL NOISE LEVELS

### Force Blower Features:

- Available with several engine options
- New 6 HP features commercial duty engine and weighs only 78 lbs. with gas and oil added

PRODUCT #	DESCRIPTION	WEIGHT
T6163	6 HP F601x XRBriggs	86 lbs.
T6164	6 HP F601v Vanguard	95 lbs.
T6126	9 HP Honda GX	161 lbs.
T6186	13 HP Honda GX	163 lbs.
T6181	18 HP Vanguard Twin	186 lbs.

\* Call for pricing



### RBHGX (HYDRAULIC)

2-WAY BROOM  
ROTATION



### RBMGX (MECHANICAL)

1-WAY BROOM  
ROTATION

## ROTARY BROOM

### Rotary Broom Features:

- Cleans along curbs, drains, and low areas at walking speeds with superior results
- Easily and quickly prepares oil spots for treatment and sealing
- Cleans in tight places where sweepers can't.
- Cleans stripes and curbs
- Long life, low replacement cost, steel bristle broom head

PRODUCT #	DESCRIPTION	WEIGHT
T6001	RBHGX [Hydraulic]	260 lbs.
T6002	RBMGX [Mechanical]	173 lbs.

\* Call for pricing



## LINELAZER® V: HP AUTOMATIC SERIES

The LineLazer V 3900, 5900, and 200HS HP Automatic Series are 2-gun professional labor saving stripers designed to deliver the most precise & consistent lines. LiveLook display, AutoLayout II, J-Log data logging, automatic & Semi automatic paint guns, Green Laser Guidance, EasyMark gun adjustment system, EZ Align tracking system, and DualComfort handle bar system.

PRODUCT #	DESCRIPTION	GPM	HP	WEIGHT
T6821	LineLazer V 3900 2-Gun HP Auto	1.25	4.0	240 lbs.
T6822	LineLazer V 5900 2-Gun HP Auto	1.60	5.5	266 lbs.
T6823	LineLazer V 200HS 2-Gun HP Auto	2.15	6.5	306 lbs.

\* Call for pricing



## LINELAZER® 3400

The LineLazer 3400 features new easy reach controls, new handle bar design with comfort grips, higher output and higher maximum pressure, new electronic pressure control, and new easy-roll wheel design. Swivel front wheel. Parking brake to prevent striper from rolling on uneven surfaces.

PRODUCT #	DESCRIPTION	GPM	HP	WEIGHT
T6860	LineLazer 3400	.75	4.0	200 lbs.

\* Call for pricing

Graco Parts Now Available at your  
SealMaster® Showroom!



### LINEDRIVER™

High-production, ride-on striping system. Connects to your line striper to immediately double your striping production. Designed to attach to 3900 and 5900 model LineLasers.

PRODUCT #	DESCRIPTION	WEIGHT
T6810	LineDriver 160 CC Honda	400 lbs.
T6812	LineDriver HD 200 CC Honda	400 lbs.

\* Call for pricing



### LINELAZER® V: STANDARD SERIES

The industry's best selling LineLazer V 3900, 5900, and 200HS Standard Series are 2-gun professional stripers designed to deliver the most precise and consistent lines. LiveLook display, EasyMark gun adjustment system, EZ Align tracking system, and DualComfort handle bar system.

PRODUCT #	DESCRIPTION	GPM	HP	WEIGHT
T6827	LineLazer V 3900 2-Gun Mech.	1.25	4.0	212 lbs.
T6828	LineLazer V 5900 2-Gun Mech.	1.60	5.5	232 lbs.
T6829	LineLazer V 200HS 2-Gun Mech.	2.15	6.5	277 lbs.

\* Call for pricing



GAMETIME FIELD MARKING PAINT  
SEE PAGE 39

### FIELDLAZER™ SPORTS FIELD STRIPER

- Airless technology for spraying higher concentrations of turf paint - delivering brighter, longer-lasting lines
- Exclusive tall-wheel cart rolls easily over ruts and cleat marks, resulting in less operator fatigue and straighter lines

PRODUCT #	DESCRIPTION	WEIGHT
T6830	Graco Fieldlazer Sports Field Striper	175 lbs.

\* Call for pricing

### ACCESSORIES FOR GRACO LINELAZER®

PRODUCT #	DESCRIPTION	WEIGHT
P159B002	GM 3900 Pump Repair Kit	1 lb.
P159B003	GM 5900 Pump Repair Kit	1 lb.
P159B004	Flex Gun Repair Kit	1 lb.
P159B010	Graco Filter Bag (207-240) replacement - 12 pack	1 lb.

\* Call for pricing

### SPRAY TIPS FOR GRACO LINELAZER®

PRODUCT #	DESCRIPTION
P159A005	[219] Parking Lot Lines 4"-6" [Standard with unit]
P159A192	[217] Long Lines 4"-6"
P159A007	[519] For curbs with one gun
P159A008	[317] For curbs with two guns, narrow stencils
P159A009	[517] Wide stencils, general painting [Standard with unit]
P159A010	[213] Athletic Court 2" lines [Use 100 mesh filter]
P159A011	[623] Cross-Walks 12" lines
P159A012	[721] Airport 24" lines with two guns

\* Call for pricing



# TITAN<sup>®</sup>

## STRIPING MACHINES



**POWRLINER™  
8955**



**POWRLINER™  
6955**

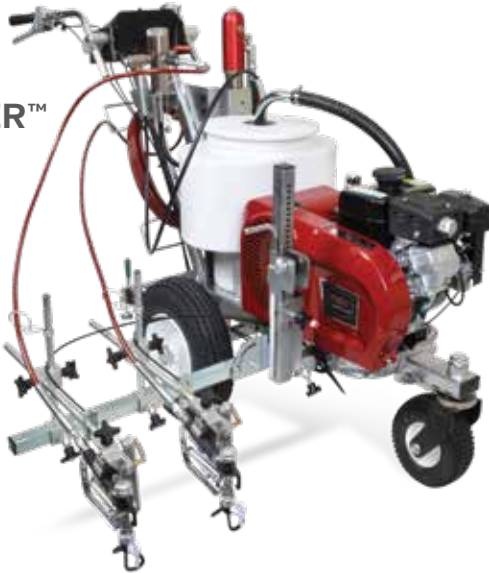

**POWRLINER™ 4955**

- 2 gun spray system
- Powered by dependable Honda Engines:  
Honda GX200 with low oil alert and electric start [PL8955]  
Honda GX160 with low oil alert and electric start [PL6955]
- Versatile gun bracket can be positioned to spray on left, right, front or rear of striper
- Precise pressure control from 400 psi to 3300 psi
- Max. Output = 2.25 GPM [model 6955], 2.50 GPM [model 8955]
- Cycle Rate = 55 per gallon [model 6955], 40 per gallon [model 8955]

- Dependable Honda GX120 engine with low oil alert and pull start
- Fast, easy, tool-free convertibility to 2 hp Extended-Life DC electrical motor
- Versatile Smart Arm™ can be positioned to spray on left, right, front or rear of striper
- Precise pressure control from 400 psi to 3300 psi
- Max. Output = 1.5 GPM
- Cycle Rate = 87 per gallon
- Fully Adjustable, Dead-Lock Handlebars Standard

PRODUCT #	DESCRIPTION	WEIGHT
T7160	PowrLiner 8955 2-Gun	255 lbs.
T7165	PowrLiner 6955 2-Gun	245 lbs.

\* Call for pricing

PRODUCT #	DESCRIPTION	WEIGHT
T7190	PowrLiner 4955 2-Gun	235 lbs.

\* Call for pricing



## POWRLINER™ 3500

- SealMaster's Best Seller
- Honda GX120 engine with low oil alert and pull start
- 0.75 GPM / 3300psi rated
- No piston rod, no packing kit
- Bead dispenser compatible
- Lazy Liner [ride-on driver] compatible

PRODUCT #	DESCRIPTION	WEIGHT
T7171	PowrLiner 3500 1-Gun	142 lbs.

\* Call for pricing

## ACCESSORIES FOR TITAN POWRLINER

PRODUCT #	DESCRIPTION
T7200	PowrLiner Bead Dispenser - 1 Gun Kit [4"-6"] with hopper is for PL4955 and larger
T7205	PowrLiner Bead Dispenser - 2 Gun Kit [4"-6"] with hopper is for PL4955 and larger
T7210	PowrLiner Bead Dispenser - 1 Gun Kit [12"] with hopper is for PL4955 and larger
T7201	HandiBead Bead Dispenser
T7202	Titan Line-Site Laser Guidance System
T7203	39" HandiCap Stencil

\* Call for pricing



GAMETIME FIELD MARKING PAINT  
SEE PAGE 39

## POWRLINER™ 850

FOR GRASS AND TURF SPORTS FIELDS  
[WILL WORK FOR PAVEMENT TOO!]

- Lightweight design makes striping and stenciling easy and fast
- Perfect for any organization or municipal budget
- Removable gun for stenciling and general painting
- Adjustable pressure from 200-3000 psi
- Max. Output = .33 GPM

PRODUCT #	DESCRIPTION	WEIGHT
T7180	PowrLiner 850	67 lbs.
P165A008	Optional Front Wheel Caster Release Kit	2 lbs.

\* Call for pricing

## TITAN TR-1 REVERSIBLE LINE STRIPING TIP



PRODUCT #	DESCRIPTION
P165A009	Athletic Courts: [2" fan / .013" orifice]
P165A010	Parking Lot Lines/Curbs: [4" fan / .017 orifice]
P165A011	Parking Lot Lines: [2" fan / .019 orifice]
P165A012	Standard with most units: [4" fan / .019 orifice]
P165A013	Speed / Production: [6" fan / .021 orifice]
P165A014	Stencils: [10" fan / 0.17 orifice]

\* Call for pricing



# MATERIAL PUMPS



A



B



C



D



E

PRODUCT #	DESCRIPTION	WEIGHT	PRICE
<b>A) ROPER 3617</b>			
P640A071	Steel Gear, 2"	91 lbs.	\$ 1,609.00
<b>B) BOWIE 2400, 3300, 3400</b>			
P640A030	Steel Gear, 2" [2400]	150 lbs.	\$ 3,059.00
P640A005	Rubber Gear, 2" [2400]	150 lbs.	\$ 2,479.75
P640A059	Steel Gear, 3" [3300]	150 lbs.	\$ 2,441.50
P640A025	Steel Gear, 3" [3400]	150 lbs.	\$ 3,339.50
P640A066	Rubber Gear, 3" [3300]	150 lbs.	\$ 1,708.75
P640A010	Rubber Gear, 3" [3400]	150 lbs.	\$ 2,812.00
<b>C) ARO DIAPHRAGM PUMPS</b>			
P640A060	ARO PD10A - 1" outlet	28 lbs.	\$ 819.25
P640A061	ARO PD15A - 1.5" outlet	60 lbs.	\$ 1,152.00
P640A068	ARO PD20A - 2" outlet	90 lbs.	\$ 1,233.00
<b>D) SANDPUMPER II HYD DUAL DIAPHRAGM</b>			
P640A024	2" outlet	195 lbs.	\$ 4,537.75
<b>E) ARO ASSEMBLY</b>			
P72000A002	ARO 1 1/2" Pump Assembly	70 lbs.	\$ 1,999.00
P72000D002	ARO 2" Pump Assembly	150 lbs.	\$ 2,155.00
<b>MATERIAL PUMP REBUILD KITS</b>			
P972A038	Graco 2150 2" - Air Valve	3 lbs.	\$ 131.75
P972A039	Graco 2150 2" - Pump	3 lbs.	\$ 747.00
P971A038	Graco 1590 1 1/2" - Air Valve	3 lbs.	\$ 131.75
P971A039	Graco 1590 1 1/2" - Pump	3 lbs.	\$ 575.75
P970A038	Graco 1040 1" - Air Valve	3 lbs.	\$ 131.75
P970A039	Graco 1040 1" - Pump	3 lbs.	\$ 468.50
P741A047	Bowie - Model 400 series	7 lbs.	\$ 790.25
P967A066	Wilden M-2	2 lbs.	\$ 353.50
P967A065	Wilden M-4	4 lbs.	\$ 374.25
P969A031	Wilden M-8	7 lbs.	\$ 408.00
P966A077	SandPumper 1.5" Material Rebuild Kit	9 lbs.	\$ 877.00
P966A076	SandPumper 1.5" Hydraulic Rebuild Kit	2 lbs.	\$ 305.75
P966A090	SandPumper II Rebuild Kit	11 lbs.	\$ 1,230.50
P975A059	ARO 1" - Pump	2 lbs.	\$ 455.00
P976A059	ARO 1 1/2" - Pump	3 lbs.	\$ 515.75
P977A059	ARO 2" - Pump	5 lbs.	\$ 512.75
P975A060	ARO 1" - Air Valve Kit	1 lb.	\$ 99.00
P976A058	ARO 1 1/2" - Air Valve Kit	1 lb.	\$ 99.00
P977A058	ARO 2" - Air Valve Kit - A Style	1 lb.	\$ 146.75
P977B058	ARO 2" - Air Valve Kit [2010 to present] - B style	1 lb.	\$ 135.50

\*Oversized parts must ship at 30 lb. rate.





## SPRAY HOSES & WAND

PRODUCT #	DESCRIPTION	WEIGHT	PRICE
<b>HOSE WITH FITTINGS (SPRAY WAND SOLD SEPARATELY)</b>			
P754B025	3/4" x 50' Spray Hose	15 lbs.	\$ 149.00
P754B026	3/4" x 75' Spray Hose	21 lbs.	\$ 195.00
P754B027	3/4" x 100' Spray Hose	28 lbs.	\$ 239.25
<b>SPRAY WAND WITH BALL VALVE &amp; SPRAY TIP</b>			
P50273B	Spray wand with ball valve & spray tip	30 lbs.	\$ 122.75
<b>REPLACEMENT BALL VALVE FOR SPRAY WAND</b>			
P397A010	3/4" carbon steel ball valve	3 lbs.	\$ 59.00



## SPROCKETS

PRODUCT #	DESCRIPTION	WEIGHT	PRICE
P428A003	60B60 - 2" Bore - 4,000 & 6,000 gal bulk tanks	26 lbs.	\$ 147.00
P428A002	60B13 - 1" Bore - on bulk tanks	3 lbs.	\$ 16.25
P428A011	60B60 - 1 1/4" Bore - on bulk tanks	23 lbs.	\$ 134.00
P428A012	60B13 - 1 1/4" Bore - on bulk tanks	3 lbs.	\$ 21.50
P429A014	80R60 - 10,000 gallon bulk tanks	50 lbs.	\$ 546.25
P740A012	Bushings - R1 x 2 15/16 for 80R60 and 80R96	8 lbs.	\$ 134.00
P429A006	80B12 - 1" Bore - 10,000 gallon bulk tank	5 lbs.	\$ 29.75
P429A020	80R96 - HD Bulk Tanks	125 lbs.	\$ 834.75
P429A019	80B60 - 1 1/2" Bore - 10,000 gallon bulk tanks	50 lbs.	\$ 375.25
P429A018	80B12 - 1 1/2" Bore - 10,000 gallon bulk tanks	5 lbs.	\$ 79.75
P429A017	80B12 - 1 1/4" Bore - HD Bulk Tanks	5 lbs.	\$ 38.00

## BEARINGS, SEALS, PLATES & PACKING GLANDS

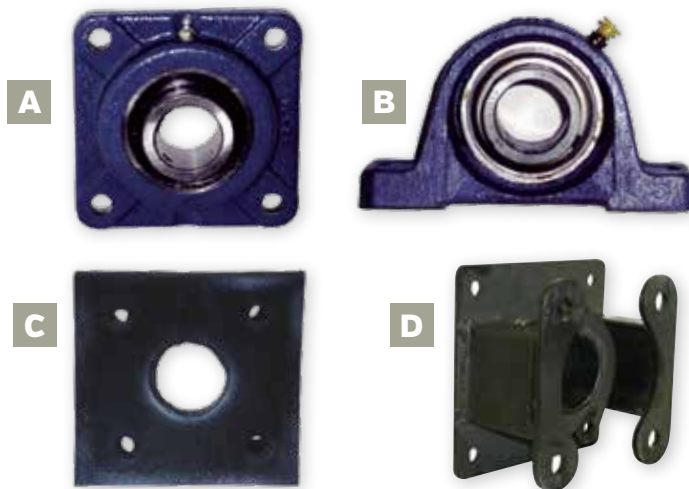

PRODUCT #	DESCRIPTION	WEIGHT	PRICE
<b>A) FLANGE BEARINGS</b>			
P434A002	1 1/4", 4-hole, 3 5/8" C to C	5 lbs.	\$ 26.75
P434A003	1 1/2", 4-hole, 4" C to C	6 lbs.	\$ 32.25
P434A004	2", 4-hole, 5 1/8" C to C	10 lbs.	\$ 56.75
P434A006	2 15/16", 4-hole, 6" C to C	29 lbs.	\$ 230.50
<b>B) PILLOW BLOCK</b>			
P435A003	1 1/4"	6 lbs.	\$ 25.50
P435A004	1 1/2"	6 lbs.	\$ 32.25
P435A005	2"	10 lbs.	\$ 85.75
<b>C) RUBBER AGITATOR SHAFT SEAL &amp; BEARING PLATES</b>			
P50137B001	2" Packing Gland Seal - Rubber	4 lbs.	\$ 34.50
P50137B006	2" Bearing Plate - Steel	4 lbs.	\$ 26.75
P50137B007	2" Seal Bearing Plate - Rubber	4 lbs.	\$ 32.75
P50137B002	1 1/2" Seal Bearing Plate - Rubber	3 lbs.	\$ 29.00
P50137B003	1 1/2" Bearing Plate - Steel	3 lbs.	\$ 25.75
P50137B004	1 1/4" Bearing Plate - Steel	3 lbs.	\$ 25.75
P50137B005	1 1/4" Seal Bearing Plate - Rubber	3 lbs.	\$ 29.00
P50137B010	2 15/16" Packing Gland Seal - Rubber	5 lbs.	\$ 41.00
P50137B011	2 15/16" Bearing Plate - Steel	5 lbs.	\$ 28.75
P50137B012	2 15/16" Seal Bearing Plate - Rubber	5 lbs.	\$ 41.00
P50137B009	1 1/4" Seal Bearing Plate - Rubber [SP 300]	1 lb.	\$ 25.75
P50137B008	1 1/4" Bearing Plate - Steel [SP 300]	2 lbs.	\$ 25.25
<b>D) STEEL PACKING GLAND</b>			
P50138C	2" Packing Gland Weldment	18 lbs.	\$ 316.75
P50138D	2 15/16" Packing Gland Weldment	20 lbs.	\$ 381.75
P50139C	2" Packing Gland Kit	35 lbs.	\$ 384.75
P50139D	2 15/16" Packing Gland Kit	40 lbs.	\$ 630.75
P638A006	1/4" Mechanical Packing	1 lb.	\$ 6.00 / ft.

## BALL VALVES



PRODUCT #	DESCRIPTION	WEIGHT	PRICE
<b>BRASS BALL VALVES</b>			
P397A009	1/2" [Manual Spray Bar]	2 lbs.	\$ 13.75
P397A001	3/4" [SandPups]	3 lbs.	\$ 14.00
P397A013	1" [Hydraulic Spray Bars]	4 lbs.	\$ 22.00
P397A012	1 1/4" [Return Line Tanks]	2 lbs.	\$ 35.00
P397A002	2" [Material Lines]	6 lbs.	\$ 67.75
P397A008	3" Brass Ball Valve	18 lbs.	\$ 196.00
<b>CARBON STEEL BALL VALVES</b>			
P397A010	3/4" [Wands]	3 lbs.	\$ 59.00
P397A006	1" [Hydraulic Spray Bars]	4 lbs.	\$ 79.50
P397A003	2" [Material Lines]	8 lbs.	\$ 257.50

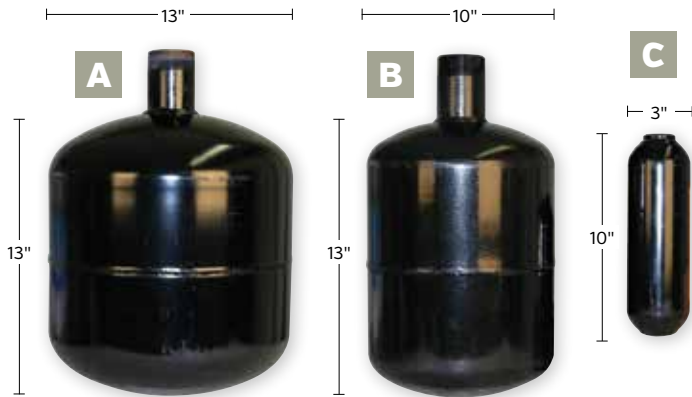

## SURGE TANKS

PRODUCT #	DESCRIPTION	WEIGHT	PRICE
<b>A) LARGE</b>			
P30003D	SandPup II, M-8 2" Male Thread	17 lbs.	\$ 141.00
<b>B) MEDIUM</b>			
P30003C	SP 1.5", M-4 2" Male Thread	14 lbs.	\$ 139.00
P30003F	Medium, 1 1/2" Male Thread	14 lbs.	\$ 139.00
<b>C) SMALL</b>			
P30003E	SandPup, M-2 3/4" Female Thread	4 lbs.	\$ 55.25

## HONDA ENGINES



PRODUCT #	DESCRIPTION	WEIGHT	PRICE
P458A022	160 CC	35 lbs.	\$ 437.00
P458A027	160 CC, 6:1 Gear Reduction	50 lbs.	\$ 633.75
P458A050	240 CC with Electric Start	75 lbs.	\$ 990.50
P458A023	390 CC with Electric Start	80 lbs.	\$ 1,014.50
P458A066	660 CC with Electric Start	115 lbs.	\$ 1,899.00
P458A074	160 CC with Electric Start	40 lbs.	\$ 664.00



## MATERIAL DISCHARGE VALVES

PRODUCT #	DESCRIPTION	WEIGHT	PRICE
<b>D) MOLASSES VALVE</b>			
P585A002	3" Molasses Valve	8 lbs.	\$ 387.00
P586A	2" Molasses Valve	5 lbs.	\$ 72.75
P585B000	2" Molasses Valve [long handle] (SM-30)	5 lbs.	\$ 94.25
P585A004	1 1/2" Molasses Valve [long handle] (SM-10)	5 lbs.	\$ 91.75
<b>E) BUTTERFLY VALVE</b>			
P398A009	3" Butterfly Valve	15 lbs.	\$ 211.75
P398L009	3" Butterfly Valve - Left - SP's	15 lbs.	\$ 239.75
P398R009	3" Butterfly Valve - Right - SP's	15 lbs.	\$ 239.75

## GATE VALVES



PRODUCT #	DESCRIPTION	WEIGHT	PRICE
P399A004	2" Brass Gate Valve	5 lbs.	\$ 65.25
P399A005	3" Brass Gate Valve	11 lbs.	\$ 135.25

## BASKET STRAINERS



### DIMENSIONS:

ITEM	HEIGHT	BOTTOM DIAMETER	TOP DIAMETER
1 Quart Basket Only	3 1/8"	3 3/8"	4 1/2"
1 Gallon Basket Only	6"	6 1/4"	7 1/2"
3 Gallon Basket Only	11 3/4"	6 1/4"	7 1/2"
Neal Basket Only	6"	3 3/8"	-
3 Gallon Basket Complete	23"	8"	-
SealRite Basket Only	6 1/4"	6 1/4"	9"
Able Basket Only	5 7/8"	6 1/4"	8 1/8"

PRODUCT #	DESCRIPTION	WEIGHT	PRICE
P50313A	Basket Only Gallon - 1/8" holes	5 lbs.	\$ 99.00
P50313B	Basket Only Quart - 1/8" holes	2 lbs.	\$ 94.75
P50313BQ	Basket Only Quart - 1/4" holes	2 lbs.	\$ 94.75
P50313BXS	Basket Only Quart - 1/16" holes	2 lbs.	\$ 95.50
P50313D	Basket Only Gallon Diamond Mesh	5 lbs.	\$ 99.00
P50313N	Basket Only NEAL - 1/8" holes	2 lbs.	\$ 92.50
P50313NQ	Basket Only - NEAL - 1/4" holes	2 lbs.	\$ 92.50
P50313Q	Basket Only Gallon - 1/4" holes	5 lbs.	\$ 99.00
P50313XL	Basket Only 3 Gallon - 1/8" holes	7 lbs.	\$ 109.25
P50313XLD	Basket Only 3 Gallon DIAMOND	7 lbs.	\$ 110.50
P50313XLQ	Basket Only 3 Gallon - 1/4" holes	7 lbs.	\$ 109.25
P50313XLS	Basket Only 3 Gallon - 1/16" holes	7 lbs.	\$ 113.50
P50313XS	Basket Only 1 Gallon 1/16" holes	5 lbs.	\$ 103.00
P50313ABQ	Basket Only - Able - 1/4" holes	5 lbs.	\$ 99.50
P50313AB	Basket Only - Able - 1/8" holes	5 lbs.	\$ 99.50
P50313SR	Basket Only - SealRite	5 lbs.	\$ 95.75

### 3 GALLON BASKET STRAINER ASSEMBLY (COMPLETE)\*

PRODUCT #	DESCRIPTION	WEIGHT	PRICE
P50147B005	3 Gallon Basket Strainer complete with 3" nipples (6 o'clock and 12 o'clock)	40 lbs.	\$ 462.25

\* NOTE: When ordering Basket Strainer Complete, please specify the hole size for basket

### 1 GALLON BASKET STRAINER ASSEMBLY (COMPLETE)\*

PRODUCT #	DESCRIPTION	WEIGHT	PRICE
P50147B002	Housing, Lid, & Basket	30 lbs.	\$ 386.00

### A) 1 - 3 GALLON BASKET STRAINER PARTS

PRODUCT #	DESCRIPTION	WEIGHT	PRICE
P50119A	Lid Gasket For 1 - Gallon And 3 - Gallon Strainer	2 lbs.	\$ 13.50
P50147D	1 - Gallon And 3 - Gallon Basket Lid Assembly	8 lbs.	\$ 111.75

### B) 1 QUART SIZE BASKET STRAINER ASSEMBLY

PRODUCT #	DESCRIPTION	WEIGHT	PRICE
P50147B004	Housing, Lid & Basket	12 lbs.	\$ 339.50
P50119B	Lid Gasket - Quart Size	2 lbs.	\$ 13.50
P50147J	1-Quart Basket Lid Assembly with Handle	4 lbs.	\$ 109.50
P50147I	Locking Handle Assy - Qt	5 lbs.	\$ 68.25

\*Oversized parts must ship at 30 lb. rate.



## TOOLS & ACCESSORIES



## STRIPE TRAFFIC MACHINE

Designed for Stripe Traffic Paints, this easy-to-use machine applies crisp, even 2" to 4" lines to concrete or asphalt.

PRODUCT #	DESCRIPTION	WEIGHT	PRICE
T6625	Stripe Traffic Machine	18 lbs.	\$ 146.99



## STRIPE ATHLETIC MARKING MACHINE

Designed for use with Stripe Athletic Field Paints. Allows application of lines up to 2" to 4" on athletic field or other turf surfaces. Features larger wheels.

PRODUCT #	DESCRIPTION	WEIGHT	PRICE
T6626	Stripe Athletic Marking Machine	19 lbs.	\$ 200.99



## MARKING GUN

Compact and lightweight, this tool is ideal for free-hand marking with any stripe inverted tip marking paint.

PRODUCT #	DESCRIPTION	WEIGHT	PRICE
T6628	Marking Gun - Non-Latex Paint	2 lbs.	\$ 24.99



## MARKING WAND

For use with all Stripe inverted tip marking paints this light-weight tool is ideal for a wide range of marking applications.

PRODUCT #	DESCRIPTION	WEIGHT	PRICE
T6627	Marking Wand	3 lbs.	\$ 32.99



**FIELD MARKING STRIPING MACHINES**

AVAILABLE ON PAGE 74-77



**NUMBER STENCILS**

AVAILABLE ON PAGE 99

ALL CATALOG PRICES ARE F.O.B. SANDUSKY, OHIO



## ATHLETIC FIELD PAINT

A specially formulated field marking paint that does not harm grass.

PRODUCT #	DESCRIPTION	WEIGHT	PRICE
P160A020	White - 12 per case	20 lbs.	\$ 82.99
P160A021	Yellow - 12 per case	20 lbs.	\$ 82.99



## INVERTED TIP MARKING PAINT

A heavy duty general purpose construction marking paint available in Fluorescent Red for bright, durable markings.

PRODUCT #	DESCRIPTION	WEIGHT	PRICE
P160A019	Fluorescent Red - 12 per case	15 lbs.	\$ 53.99



## STRIPE EXTRA TRAFFIC PAINT

Formulated for heavy duty application in high traffic areas. Offers maximum adhesion and durability. Ideally suited for asphalt or concrete. Do not apply to fresh sealer.

PRODUCT #	DESCRIPTION	WEIGHT	PRICE
P160A013	White - 12 per case	20 lbs.	\$ 108.99
P160A014	Yellow - 12 per case	18 lbs.	\$ 108.99
P160A009	Black - 12 per case	18 lbs.	\$ 108.99

## STRIPE TRAFFIC PAINT

High solids traffic paint ideally suited for asphalt or concrete. Do not apply to fresh sealer.

PRODUCT #	DESCRIPTION	WEIGHT	PRICE
P160A015	White - 12 per case	18 lbs.	\$ 74.99
P160A016	Yellow - 12 per case	18 lbs.	\$ 77.99
P160A017	Handicap Blue - 12 per case	18 lbs.	\$ 77.99
P160A018	Firelane Red - 12 per case	18 lbs.	\$ 79.99



PLAYGROUND STENCILS  
AVAILABLE ON PAGE 100



## LIGHTWEIGHT ALUMINUM SPORT SQUEEGEE

THE ULTIMATE SQUEEGEE

Ideal for Tennis Court Color Coatings as well as pavement sealers. Features soft, tapered rubber blade for superior results on both sport courts as well as asphalt pavement.

PRODUCT #	DESCRIPTION	WEIGHT	PRICE
T1277	24" Sport Squeegee Complete	4 lbs.	\$ 79.99
T1272	36" Sport Squeegee Complete	6 lbs.	\$ 91.99
T1292	48" Sport Squeegee Complete	8 lbs.	\$ 109.99
T1311	60" Lightweight Squeegee Complete	9 lbs.	\$ 104.99
<b>A) RUBBER REFILLS:</b>			
T1278	24" Sport Rubber Blade Refill	3 lbs.	\$ 22.99
T1326	36" Sport Rubber Blade Refill	3 lbs.	\$ 30.99
T1327	48" Sport Rubber Blade Refill	3 lbs.	\$ 40.99
T1324	60" Lightweight Squeegee Rubber Refill	4 lbs.	\$ 39.99
<b>B) RUBBER REFILLS:</b>			
T1281	36" Rubber Refill	3 lbs.	\$ 25.99
T1301	48" Rubber Refill	3 lbs.	\$ 32.99
T1321	60" Rubber Refill	4 lbs.	\$ 39.99

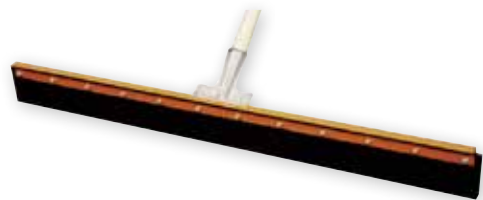
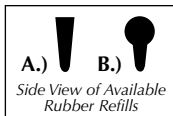

## SEALCOATING SQUEEGEE

These heavy duty neoprene rubber sealcoating squeegees are available in 24" and 36" widths. Available with or without 6' wood handle. Rubber refills also available.

PRODUCT #	DESCRIPTION	WEIGHT	PRICE
T1040	24" Squeegee w/handle	6 lbs.	\$ 53.99
T1100	36" Squeegee w/handle	7 lbs.	\$ 67.99
T1030	24" Squeegee w/out handle	4 lbs.	\$ 40.99
T1090	36" Squeegee w/out handle	5 lbs.	\$ 55.99
T1050	24" Neoprene Refill	2 lbs.	\$ 22.99
T1110	36" Neoprene Refill	3 lbs.	\$ 31.99
T2010	6' Wood Tapered Handle	2 lbs.	\$ 11.99



## ALUMINUM SEALER APPLICATOR BRUSH

Quality brush applicator provides the ideal finish for pavement sealers. Available in 24" and 36" widths.

PRODUCT #	DESCRIPTION	WEIGHT	PRICE
T1150	24" Complete	4 lbs.	\$ 50.99
T1170	36" Complete	5 lbs.	\$ 53.99
T2030	Applicator Brush Handle	2 lbs.	\$ 15.99
T2000	Aluminum Brush Holder	1 lb.	\$ 19.99
T1160	24" Refill	2 lbs.	\$ 16.99
T1180	36" Refill	3 lbs.	\$ 19.99



## WOOD SEALER APPLICATOR BRUSH

Quality brush applicator provides the ideal finish for pavement sealers. Available in 24" and 36" widths.

PRODUCT #	DESCRIPTION	WEIGHT	PRICE
T1194	24" Complete	4 lbs.	\$ 53.99
T1195	36" Complete	4 lbs.	\$ 56.99
T1191	Brush Holder	1 lb.	\$ 22.99
T1196	24" Brush only	2 lbs.	\$ 22.99
T1197	36" Brush only	2 lbs.	\$ 26.99
T2010	6-foot Wood Tapered Handle	2 lbs.	\$ 11.99



## SEALER EDGING BRUSH

Also ideal for Oil Spot Primer



The ideal sealer brush for edging along concrete edges, curbs, light poles, parking blocks, etc. Brush features heavy polypropylene bristles set in heavy duty plastic for added durability.

PRODUCT #	DESCRIPTION	WEIGHT	PRICE
T1260	Edging Brush w/handle	2 lbs.	\$ 25.99
T1265	Edging Brush only	1 lb.	\$ 14.99
T1255	6-foot Threaded Handle	1 lb.	\$ 10.99



## DRAG STRIP MACHINE BRUSH

Professional sealer applicator brushes designed to be attached to sealcoating machines. Provides for uniform sealer application.

PRODUCT #	DESCRIPTION	WEIGHT	PRICE
T1210	48" Drag Strip Brush	4 lbs.	\$ 93.99
T1220	60" Drag Strip Brush	5 lbs.	\$ 121.99
T1230	72" Drag Strip Brush	5 lbs.	\$ 125.99
T1240	96" Drag Strip Brush	6 lbs.	\$ 156.99
T1250	120" Drag Strip Brush	7 lbs.	\$ 201.99

\* NOTE: Brushes 96" and shorter can be shipped UPS. 120" brush must be shipped common carrier.

• Drag Brush Holder sold separately. For order information visit [sealmasterparts.com](http://sealmasterparts.com)



## CARBON STEEL STREET BROOM

Carbon steel bristles for long lasting cleaning power. Built strong to withstand the rigors of driveway and parking lot cleaning.

PRODUCT #	DESCRIPTION	WEIGHT	PRICE
T1730	Broom w/out handle	4 lbs.	\$ 40.99
T2010	6-foot Wood Handle	2 lbs.	\$ 11.99



## POLYPROPYLENE STREET BROOM

Extra stiff polypropylene bristles for maximum cleaning power.

PRODUCT #	DESCRIPTION	WEIGHT	PRICE
T1710	Broom w/out handle	4 lbs.	\$ 25.99
T2010	6-foot Wood Handle	2 lbs.	\$ 11.99



## OIL SPOT CLEANING BROOM

The ideal tool for cleaning and scraping oil and grease spots prior to priming and sealing. Broom features steel bristles for optimum cleaning power.

PRODUCT #	DESCRIPTION	WEIGHT	PRICE
T1750	Oil Spot Cleaning Broom w/out handle	3 lbs.	\$ 41.99
T2010	6-foot Wood Handle	2 lbs.	\$ 11.99





## STEEL SPRAY TIPS

These hardened steel spray tips are designed for long lasting performance even with heavy sand loadings. Up to 2 times the life of other steel spray tips. Available in 1/4" and 3/8" thread sizes. Tip size openings from 80/20 to 80/100.

PRODUCT #	DESCRIPTION	WEIGHT	PRICE
P449A011	80/20 - 1/4"	1 lb.	\$ 7.99
P449A012	80/30 - 1/4"	1 lb.	\$ 7.99
P449A013	80/50 - 1/4"	1 lb.	\$ 7.99
P449A015	80/70 - 1/4"	1 lb.	\$ 7.99
P449A008	80/50 - 3/8"	1 lb.	\$ 7.99
P449A004	80/70 - 3/8"	1 lb.	\$ 7.99
P449A018	80/100 - 3/8"	1 lb.	\$ 7.99
<b>SPRAY TIP ADAPTORS:</b>			
P1010A004	1/2" male thread to 3/8" female thread	1 lb.	\$ 2.99
P1010A003	1/2" male thread to 1/4" female thread	1 lb.	\$ 2.99
P1010A001	3/8" male thread to 1/4" female thread	1 lb.	\$ 2.99

## CERAMIC SPRAY TIPS



Sprays up to 10 times the amount of pavement sealer as regular steel spray tips while maintaining a precision spray pattern. Available with 3/8" thread and 80/50 tip size opening. Replacement inserts sold separately.

PRODUCT #	DESCRIPTION	WEIGHT	PRICE
P449A009	80/50 - 3/8"	2 lbs.	\$ 26.99
P449A022	Ceramic Replacement Tip Insert	1 lb.	\$ 18.99



## CRACK FILLER POUR POT

The easy way to apply hot or cold pour crack sealing materials. Pour pot features stand up design, fingertip control valve, and heavy gauge steel construction.

PRODUCT #	DESCRIPTION	WEIGHT	PRICE
T1350	Round Design Pour Pot	8 lbs.	\$ 101.99



## CRACK BANDING MACHINE

*Ideal for Applying Hot and Cold Crack Sealants*

Ideal for pouring and applying hot pour materials. Steel squeegee design applies even 3" band of crack filling material. Fingertip material control valve. 4-gallon capacity. Also the ultimate tool for applying cold pour crack sealants.

PRODUCT #	DESCRIPTION	WEIGHT	PRICE
T7500	Crack Banding Machine	35 lbs.	\$ 369.99



## U-SHAPE CRACK FILLING SQUEEGEE



Ideal for applying hot or cold pour crack filling materials. Durable one piece construction with wood handle. Flexible neoprene squeegee rubber follows contour of pavement for professional crack filling results.

PRODUCT #	DESCRIPTION	WEIGHT	PRICE
T1400	U-Shape Squeegee	5 lbs.	\$ 64.99
T1410	Rubber Refill	2 lbs.	\$ 10.99
T1455	U-Shape Hi-Temp Refill	2 lbs.	\$ 16.99



## V-SHAPE CRACK FILLING SQUEEGEE



Designed for hot or cold applied crack filling materials. Durable one piece construction with wood handle. Flexible neoprene squeegee rubber. Available in push or pull design.

PRODUCT #	DESCRIPTION	WEIGHT	PRICE
T1420	Push Type	4 lbs.	\$ 64.99
T1430	Pull Type	4 lbs.	\$ 64.99
T1440	Rubber Refill	2 lbs.	\$ 13.99
T1445	Hi-Temp Rubber Refill	2 lbs.	\$ 16.99



## THE SANDLINER™

This unit is hand-held by design for ultimate mobility and ease of use. The absence of cumbersome wheels means that you won't track through molten crack filler or struggle with a needlessly awkward or heavy device.

The SandLiner's upright operating position is less stressful to your lower back and shoulders than conventional sanding methods.

This unit weighs just 22 lbs. fully loaded.

PRODUCT #	DESCRIPTION	WEIGHT	PRICE
T7400	SandLiner Handheld 16"	9 lbs.	\$ 189.99



## BACKER ROD

Foam bedding material design for backfilling cracks prior to crack sealing. Enables you to control crack sealing material usage. Available in 5/8" and 7/8" widths (ideal for 1/2" and 3/4" cracks). Packaged in 100 foot rolls.

PRODUCT #	DESCRIPTION	WEIGHT	PRICE
T1470	5/8" width	1 lb.	\$ 23.99/roll
T1480	7/8" width	1 lb.	\$ 40.99/roll



## ASPHALT LUTE

Lightweight magnesium/aluminum alloy. Strong wrap-around bracing system. 82" x 1 3/8" diameter, yellow powder-coated aluminum handle for a greater controlled reach and easier clean-up. Available in 30", 36", and 42" widths.

PRODUCT #	DESCRIPTION	WEIGHT	PRICE
T1605	30-inch Lute with handle	3 lbs.	\$ 58.99
T1600	36-inch Lute with handle	4 lbs.	\$ 61.99
T1610	42-inch Lute with handle	5 lbs.	\$ 63.99



## ASPHALT RAKE

Heavy-duty one piece construction rake designed for tough use with hot asphalt paving mix. Sturdy 7-foot wood handle. The only rake that is double-riveted for added strength.

PRODUCT #	DESCRIPTION	WEIGHT	PRICE
T1620	Asphalt Rake	7 lbs.	\$ 80.99



## ASPHALT SHOVELS



The perfect combination of scoop and traditional shovel. Features hard wood handles. Available with D-handle or straight handle design.

PRODUCT #	DESCRIPTION	WEIGHT	PRICE
T1670	36" D-handle	6 lbs.	\$ 37.99
T1680	44" Straight handle	7 lbs.	\$ 29.99



## HEAVY-DUTY HAND TAMPER

The ideal tool for small patchwork and tamping hard to reach areas. All steel construction with 3/8" x 8" x 8" base plate.

PRODUCT #	DESCRIPTION	WEIGHT	PRICE
T1650	Heavy-Duty Hand Tamper	17 lbs.	\$ 87.99



## CHAPIN SPRAYER

IDEAL FOR SPRAYING OIL SPOT PRIMERS

Quality hand pump sprayer designed for spraying oil spot primers, concrete sealers, curing compounds, and more. Shoulder strap and spray tip included. Holster for nozzles and extension. Available in 3 and 3.5 gallon capacities.

PRODUCT #	DESCRIPTION	WEIGHT	PRICE
T2310	3 - Gallon	11 lbs.	\$ 94.99
T2320	3.5 - Gallon	11 lbs.	\$ 128.99

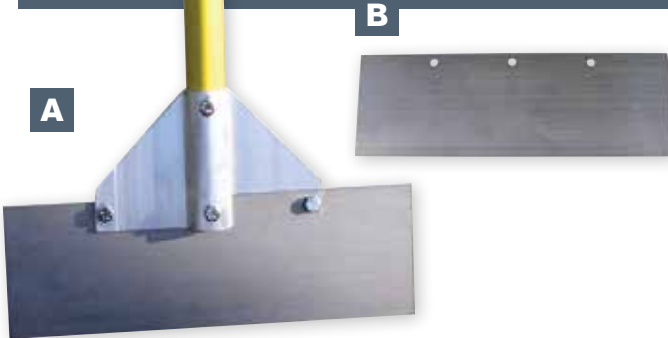

## SUPER SCRAPER

Ideal for scraping tennis courts and parking lots. Lightweight durable construction for lasting performance. Replacement blades available.

PRODUCT #	DESCRIPTION	WEIGHT	PRICE
T1950	A) Super Scraper	7 lbs.	\$ 62.99
T1960	B) Replacement Blades	2 lbs.	\$ 17.99



## ASPHALT SHOES

*Keep Your Feet Cool On Pavement And Don't Leave Foot Prints!*

PaveMaster Asphalt Shoes are designed to tamp and compact the asphalt mat where power and hand rollers cannot reach. Around the paver or behind it, PaveMaster Shoes spread your weight to avoid gouging the mat.

PRODUCT #	DESCRIPTION	WEIGHT	PRICE
T2045	PaveMaster Asphalt Shoes	4 lbs.	\$ 85.99



## PAIL OPENERS

The easy way to remove lids from pails. Simply hook lid and lift off. Available in cast aluminum or plastic.

PRODUCT #	DESCRIPTION	WEIGHT	PRICE
T1905	Cast Aluminum Pail/Drum	1 lb.	\$ 12.99
T1910	Plastic	1 lb.	\$ 5.99



## U.S. TAPE DURAWHEEL

A.) The DW-1000 is a 12.5" diameter professional grade measuring wheel. Models measure in ft./10ths or m/dm.

Features include:

- Balanced in-line design
- Sealed roller bearings
- Hi-traction tire
- Folding handle with hefty pistol grip
- Belt driven counter for long life and smooth operation

B.) The DW-PRO is a 12.5" diameter heavy duty commercial grade measuring wheel. Model measures in ft./10ths.

Features include:

- Lifetime warranty on the counter
- Balanced in-line design
- Trigger brake



PRODUCT #	DESCRIPTION	WEIGHT	PRICE
T2135	A) DW-1000, Ft./10ths	6 lbs.	\$ 159.99
T2136	DW-1000, m/dm (metric)	6 lbs.	\$ 159.99
T2137	B) DW-PRO without case	6 lbs.	\$ 180.99



## FASTMEASURE DISTANCE DEVICE

FastMeasure distance measuring device easily mounts on the dashboard and is designed to help contractors quickly and accurately measure parking lots, roads, utilities and more in the comfort of your car up to highway speeds with unparalleled accuracy. FastMeasure can also be mounted on ATV's, concrete saws, crack routers, striping machines, etc., for reliable job accounting.

- Small footprint - 3"w x 1.5"h x 1.75" d
- Measures in feet or meters
- Displays mph, kph, or feet per minute
- Very accurate at low and high speeds
- Reset count to zero on the fly
- Hold count feature

PRODUCT #	DESCRIPTION	PRICE
T2165	FastMeasure Distance Device	\$ 399.99



## KESON MEASURING WHEELS

PRODUCT #	DESCRIPTION	PRICE
T2170	A) RoadRunner Measuring Wheel 4"	\$ 44.99
T2175	B) RoadRunner Measuring Wheel 12.5"	\$ 90.99
T2180	C) Metal Pro Measuring Wheel 11.5"	\$ 162.99

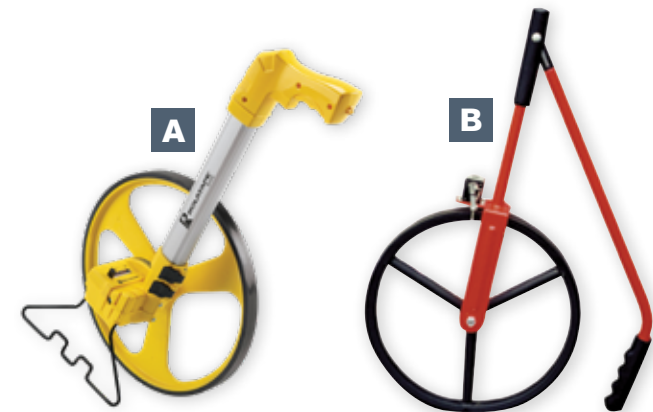

## ROLATAPE MEASURING WHEELS

Reliable, long distance measuring wheels for indoor and outdoor surfaces.

A.) **Model RT312** - Features 12" diameter wheel, telescopic handle, and 10,000 foot counter.

B.) **Model 32-300 RP** - Steel construction with 11" wheel, fold down handle, and 100,000 foot counter.

PRODUCT #	DESCRIPTION	WEIGHT	PRICE
T2110	A) Model RT312	4 lbs.	\$ 135.99
T2120	B) Model 32-300 RP	4 lbs.	\$ 152.99

## GIANT CHALK BOX



## MARKING CHALK

PRODUCT #	DESCRIPTION	PRICE
T4780	Giant Chalk Box - 150 ft line	\$ 42.99
T4785W8	Chalk - white - 8 oz.	\$ 1.99
T4785Y8	Chalk - yellow - 8 oz.	\$ 1.99



## TRAFFIC CONTROL SIGNS

Heavy-duty aluminum traffic signs feature reflective surface for maximum visibility and pre-drilled holes for ease of mounting. Rectangular sign dimensions are 12" x 18". Stop signs are available in three sizes.

PRODUCT #	DESCRIPTION	WEIGHT	PRICE
T8010	Reserved Parking (Handicap)	2 lbs.	\$ 38.99
T8020	No Parking	2 lbs.	\$ 34.99
T8025	Reserved Parking	2 lbs.	\$ 34.99
T8030	Visitor Only	2 lbs.	\$ 34.99
T8040	Employee Parking Only	2 lbs.	\$ 34.99
T8050	No Parking Loading Zone	2 lbs.	\$ 34.99
T8060	Do Not Block Drive	2 lbs.	\$ 34.99
T8070	No Parking Tow Away Zone	2 lbs.	\$ 34.99
T8080	No Trucks [24" x 24"]	2 lbs.	\$ 92.99
T8090	No Parking Firelane	2 lbs.	\$ 34.99
T8100	24" Stop Sign	5 lbs.	\$ 66.99
T8101	30" Stop Sign	5 lbs.	\$ 98.99
T8102	36" Stop Sign	5 lbs.	\$ 113.99
T8110	8 ft. Green U-Channel Post	16 lbs.	\$ 35.99
T8120	12" x 6" Van Accessible	1 lb.	\$ 21.99



Cone NOT included with safety signs

## SAFETY SIGNS

Conveniently attaches to top of plastic traffic cones. Bright, highly visible durable plastic. Sign dimensions are 10" x 12".

PRODUCT #	DESCRIPTION	WEIGHT	PRICE
T2250	Men Working	1 lb.	\$ 17.99
T2260	Wet Tar	1 lb.	\$ 17.99
T2270	Arrow	1 lb.	\$ 17.99
T2280	No Thru Traffic	1 lb.	\$ 17.99



## IDEAL SHIELD SIGN BASE

- Save time on installation. No core drilling or anchor assembly required
- No painting, ever
- Fill with concrete, sand, or water
- Colors: Yellow, Blue, or Red

PRODUCT #	DESCRIPTION	WEIGHT	PRICE
T2330Y	Yellow Base w/wheels	24 lbs.	\$ 177.99
T2330B	Blue Base w/wheels	24 lbs.	\$ 177.99
T2330R	Red Base w/wheels	24 lbs.	\$ 177.99

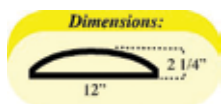

End caps sold separately



## EASY RIDER SPEED BUMPS

Premium quality recycled rubber speed bumps. Easy Rider rubber speed bumps are ideal for effective speed reduction on roads, parking lots, and indoor garages. Easy Rider will not warp, crack, chip, or rot. Polyurethane yellow paint provides high visibility. Light-weight for easy handling and storage.

**Installation methods: Installs with rebar spikes on asphalt surfaces and lag bolts and anchors on concrete surfaces. (see below)**

PRODUCT #	DESCRIPTION	WEIGHT	PRICE
T2465	4-foot - 3 hole	40 lbs.	\$ 127.99
T2475	6-foot - 4 hole	60 lbs.	\$ 176.99
T2466	Speed Bump End Caps - set of 2	12 lbs.	\$ 50.99/set

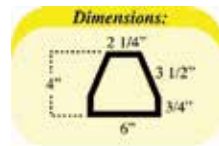

## PARK-IT PARKING CURBS

Premium quality recycled rubber parking curbs. Park-It Curbs are ideal for effective delineation of parking and for use in the protection of walls and vehicles in garages and other parking applications. Park-It will not warp, crack, chip, or rot. Lightweight for easy handling and storage.

**Installation methods: Installs with rebar spikes on asphalt surfaces and lag bolts and anchors on concrete surfaces. (see below)**

PRODUCT #	DESCRIPTION	WEIGHT	PRICE
T2430	3-foot - 2 hole (black/yellow)	20 lbs.	\$ 30.99
T2435	6-foot - 4 hole (black/yellow)	40 lbs.	\$ 53.99
T2431	3-foot - 2 hole (blue/white)	20 lbs.	\$ 37.99
T2437	6-foot - 4 hole (blue/white)	40 lbs.	\$ 82.99



## PARKING BLOCK & SPEED BUMP LAG BOLT ASSEMBLIES

Each Lag Bolt Assembly includes one lag bolt, one lag bolt anchor, and two washers. Available in 5.5" length (for speed bumps); and 8" length (for parking blocks).

- For use in Concrete

PRODUCT #	DESCRIPTION	WEIGHT	PRICE
T2447	5.5-inch Lag Bolt Assembly (speed bumps)	1 lb.	\$ 7.99 ea.
T2448	8-inch Lag Bolt Assembly (parking curbs)	1 lb.	\$ 8.99 ea.



## PARKING BLOCK & SPEED BUMP INSTALLATION SPIKES

- For use in Asphalt

PRODUCT #	DESCRIPTION	WEIGHT	PRICE
T2441	14-inch Rebar Spikes	1 lb.	\$ 4.99 ea.



## IDEAL SHIELD® POST SLEEVES

- Available in 1/4" and 1/8" Nominal Wall Thickness
- Dome Top - Low Density Thermoplastic Polyethylene (LDPE) with Ultra-Violet and Anti-Static Additives
- Installation Tape Included
- Available for 4 - 4 1/2" and 6 - 6 5/8" pipes

### 1/8" NOMINAL WALL THICKNESS X 4" DIAMETER [\*HEIGHT 60"]:

PRODUCT #	DESCRIPTION	PRICE
T2455Y	1/8" x 4" diameter - Yellow post sleeve	\$ 34.99
T2455R	1/8" x 4" diameter - Red post sleeve	\$ 34.99
T2455W	1/8" x 4" diameter - White post sleeve	\$ 34.99
T2455B	1/8" x 4" diameter - Blue post sleeve	\$ 34.99

### 1/8" NOMINAL WALL THICKNESS X 6" DIAMETER [\*HEIGHT 60"]:

PRODUCT #	DESCRIPTION	PRICE
T2456Y	1/8" x 6" diameter - Yellow post sleeve	\$ 34.99
T2456R	1/8" x 6" diameter - Red post sleeve	\$ 34.99
T2456W	1/8" x 6" diameter - White post sleeve	\$ 34.99
T2456B	1/8" x 6" diameter - Blue post sleeve	\$ 34.99

### 1/4" NOMINAL WALL THICKNESS X 4" DIAMETER [\*HEIGHT 52"]:

PRODUCT #	DESCRIPTION	PRICE
T2450Y	1/4" x 4" diameter - Yellow post sleeve	\$ 54.99
T2450R	1/4" x 4" diameter - Red post sleeve	\$ 54.99
T2450B	1/4" x 4" diameter - Blue post sleeve	\$ 54.99
T2450G	1/4" x 4" diameter - Green post sleeve	\$ 54.99
T2450BK	1/4" x 4" diameter - Black post sleeve	\$ 54.99
T2450W	1/4" x 4" diameter - White post sleeve	\$ 54.99
T2450GY	1/4" x 4" diameter - Gray post sleeve	\$ 54.99

### 1/4" NOMINAL WALL THICKNESS X 6" DIAMETER [\*HEIGHT 52"]:

PRODUCT #	DESCRIPTION	PRICE
T2451Y	1/4" x 6" diameter - Yellow post sleeve	\$ 54.99
T2451R	1/4" x 6" diameter - Red post sleeve	\$ 54.99
T2451B	1/4" x 6" diameter - Blue post sleeve	\$ 54.99
T2451G	1/4" x 6" diameter - Green post sleeve	\$ 54.99
T2451BK	1/4" x 6" diameter - Black post sleeve	\$ 54.99
T2451W	1/4" x 6" diameter - White post sleeve	\$ 54.99
T2451GY	1/4" x 6" diameter - Gray post sleeve	\$ 54.99



## TRAFFIC CONES

Control traffic flow with these durable P.V.C. bright orange traffic cones. Available in 12 and 18 inch sizes.



PRODUCT #	DESCRIPTION	WEIGHT	PRICE
T2200	12-inch Cone	3 lbs.	\$ 9.99
T2210	18-inch Cone	4 lbs.	\$ 10.99

## CAUTION TAPE



This bright yellow caution tape secures job site from pedestrians and entry prior to completion. Unique box spool design packaging keeps tape protected during storage and allows for easy use. Packaged in 1,000 foot rolls.

PRODUCT #	DESCRIPTION	WEIGHT	PRICE
T2300	1,000 ft. Roll	3 lbs.	\$ 19.99

## PLY-NINE PROTECTIVE SKIN GEL



Excellent barrier to coal tar sealer. Simply rub on skin prior to sealcoating. 5.5 oz. tube

PRODUCT #	DESCRIPTION	WEIGHT	PRICE
T4900	Ply-Nine	1 lb.	\$ 13.99



## PLYTHOL

Soothes and refreshes skin. Ease the discomfort of dry skin. 5 oz. tube.

PRODUCT #	DESCRIPTION	WEIGHT	PRICE
T4910	Plythol Cream	1 lb.	\$ 15.99



## DISPOSABLE COVERALLS, PANTS & SHOE COVERS

Lightweight design for added comfort. Economical, disposable. Saves on clothing costs. Neat, professional appearance.

PRODUCT #	DESCRIPTION	WEIGHT	PRICE
T4815	Pants w/elastic waist band - XL	1 lb.	\$ 3.99
T4816	Pants w/elastic waist band - XXL	1 lb.	\$ 4.99
T4810	Coveralls - XL	1 lb.	\$ 7.99
T4820	Coveralls - XXL	1 lb.	\$ 8.99
T4825	Shoe Covers	1 lb.	\$ 4.99

## PARKING LOT PROTRACTOR

The quick and easy way to lay out striping angles.

PRODUCT #	DESCRIPTION	WEIGHT	PRICE
T4795	Protractor	1 lb.	\$ 72.99

## PRE-MARKED LAYOUT TAPE



The ideal tool for fast and easy parking lot striping layout. Five pre-marked layouts include: 8'-6", 9'-0", and 10'-0" straight in parking; along with 60 degree parking of 9'-10" and 10'-0". Total length: 300 ft.

PRODUCT #	DESCRIPTION	WEIGHT	PRICE
T4790	Layout Tape	5 lbs.	\$ 324.99

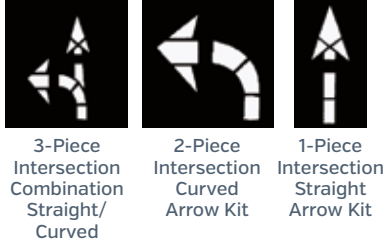

## PAVEMENT MARKING STENCILS

These stencils are made of heavy duty plastic, thick enough to withstand the daily use required by professionals in the pavement marking industry, yet light enough to "flow" with the pavement to obtain sharp lines every time. Easy maintenance, virtually no build-up due to the smooth non-stick surface. When paint dries, just flex and peel paint away.

PRODUCT #	DESCRIPTION	PRICE
<b>HANDICAP SYMBOLS</b>		
T2500	Small, 21 1/2" H. [to DOT]	\$ 44.99
T2510	Medium, 34" H. [to DOT]	\$ 82.99
T2520	Large, 39" H. [standard-most areas] [to DOT]	\$ 98.99
T2530	Intl. & Calif./Alaska 53 1/2" H. [to DOT]	\$ 128.99
T2540	63" H. [to DOT]	\$ 149.99
T2550	72" H. [to DOT]	\$ 169.99
<b>BICYCLE LANE SYMBOLS</b>		
T2560	48" H. [to FHWA Standard]	\$ 96.99
T2570	78" H. [to FHWA Standard]	\$ 137.99
<b>PEDESTRIAN CROSSING SYMBOLS</b>		
T2580	52" H.	\$ 107.99
<b>ARROW KIT</b>		
T2590	Small [2 pieces] 1-straight, 1-curved; 42" O.A.L. ea.	\$ 100.99
T2600	Medium [3 pieces] 62" O.A.L., 1-head-30", 1-straight tail 32", 1-curved tail 32"	\$ 123.99
T2610	Large [3 pieces] 84" O.A.L., 1-head 42", 1-straight tail 42", 1-curved tail 42"	\$ 151.99
T2620	Arrow - straight 60" long [1 piece]	\$ 107.99
T2630	Arrow - curved 60" long [1 piece]	\$ 107.99
T2640	Arrow - straight 72" [1 piece]	\$ 131.99
T2650	Arrow - curved 72" long [1 piece]	\$ 131.99
T2690	McDonald's Kit - 6 piece kit includes 34" THANK, YOU, DRIVE, THRU, and an Arrow with a Circle Around it	\$ 689.99
<b>FEDERAL SPEC. ARROW STENCILS - FOR HIGHWAYS AND ROADS</b>		
T2660	Straight 10' long [1 piece] [to DOT-MUTCD]	\$ 248.99
T2670	Curved 8'4" long [2 pieces][to DOT-MUTCD]	\$ 268.99
T2680	Combination straight/curved [3 pieces] 12'9" long [to DOT-MUTCD]	\$ 433.99



## WORD STENCILS

Any wording available - i.e. NO PARKING - RESERVED - FIRE LANE - STOP - etc., including mix of two sizes or letters/numbers.

For PRICING count number of letters in the desired wording and multiply times the price shown for the size letters you need. [EXAMPLE: a 12" NO PARKING stencil = 9 letters x \$12.99 per letter = \$116.91 for that stencil].

**NOTE: For pricing DO NOT COUNT space between words, comma, period, hyphen, or slash.**

PRODUCT #	DESCRIPTION	PRICE
T2700	3"	\$ 6.99
T2710	4"	\$ 6.99
T2720	5"	\$ 7.99
T2730	6"	\$ 7.99
T2740	8"	\$ 9.99
T2750	10"	\$ 11.99
T2760	12"	\$ 12.99
T2770	15"	\$ 13.99
T2780	18"	\$ 13.99
T2790	24" x 9"	\$ 15.99
T2800	24" x 12"	\$ 22.99
T2810	24" x 16"	\$ 28.99
T2820	30" x 9"	\$ 21.99
T2830	30" x 12"	\$ 25.99
T2840	30" x 16"	\$ 32.99
T2850	36" x 9"	\$ 22.99
T2860	36" x 12"	\$ 27.99
T2870	36" x 16"	\$ 35.99
T2880	42" x 12"	\$ 40.99
T2890	42" x 16"	\$ 40.99
T2900	48" x 12"	\$ 36.99
T2910	48" x 16"	\$ 46.99
T2920	60" x 12"	\$ 43.99
T2930	60" x 16"	\$ 56.99
T2940	72" x 16"	\$ 62.99
T2950	84" x 16"	\$ 73.99
T2960	96" x 16"	\$ 81.99

**SPECIAL:**

D.O.T. "SCHOOL" - 3-piece stencil [120" x 32"] \$743.99 for entire word.  
 Word stencils in size 48" thru 96" come as individual characters.  
 Stencils 15" thru 96" are ELONGATED lettering, designed to be read at a DRIVING ANGLE, as per DOT where applicable.



## ALPHABET STENCIL SETS

Letters A-Z in several sizes.

- The 39-piece set consists of: AA, B, CC, D, EE, F, G, H, II, J, K, L, M, NN, OO, P, Q, RR, SS, T, U, V, W, X, Y, Z, 2-spacers, 2-end pieces
- The 29 piece set consists of A-Z, 1-spacer, 2-end pieces
- The alphabet sets are interlocking and may also be used in combination with numbers (only up to 42", 48" and up do not interlock)

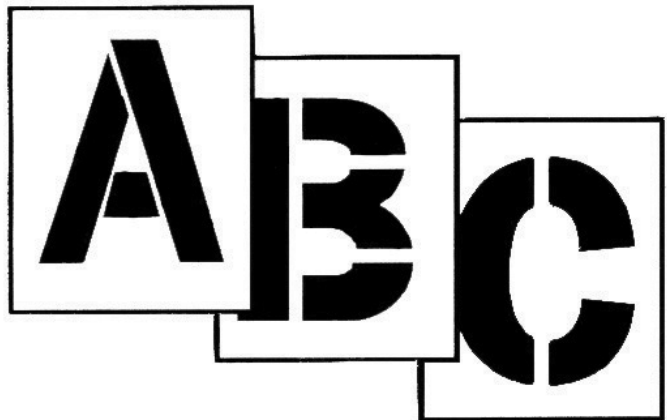

PRODUCT #	DESCRIPTION	PRICE
<b>4" HIGH, 2 1/2" WIDTH, 5/8" STROKE SIZE</b>		
T3080	39-piece set	\$ 143.99
T3090	29-piece set	\$ 118.99
<b>5" HIGH, 3 1/4" WIDTH, 3/4" STROKE SIZE</b>		
T3110	39-piece set	\$ 169.99
T3120	29-piece set	\$ 139.99
<b>6" HIGH, 3 3/4" WIDTH, 1" STROKE SIZE</b>		
T3140	39-piece set	\$ 212.99
T3150	29-piece set	\$ 174.99
<b>8" HIGH, 5" WIDTH, 1 1/4" STROKE SIZE</b>		
T3170	39-piece set	\$ 300.99
T3180	29-piece set	\$ 250.99
<b>10" HIGH, 6" WIDTH, 1 5/8" STROKE SIZE</b>		
T3200	39-piece set	\$ 375.99
T3210	29-piece set	\$ 316.99
<b>12" HIGH, 9" WIDTH, 2" STROKE SIZE</b>		
T3230	39-piece set	\$ 428.99
T3240	29-piece set	\$ 374.99
<b>15" HIGH, 9" WIDTH, 2" STROKE SIZE</b>		
T3260	39-piece set	\$ 495.99
T3270	29-piece set	\$ 432.99
<b>18" HIGH, 9" WIDTH, 2" STROKE SIZE</b>		
T3290	39-piece set	\$ 564.99
T3300	29-piece set	\$ 491.99
<b>24" HIGH, 9" WIDTH, 2" STROKE SIZE</b>		
T3320	39-piece set	\$ 701.99
T3330	29-piece set	\$ 611.99
<b>24" HIGH, 12" WIDTH, 3" STROKE SIZE</b>		
T3350	39-piece set	\$ 907.99
T3360	29-piece set	\$ 792.99
<b>24" HIGH, 16" WIDTH, 4" STROKE SIZE</b>		
T3380	39-piece set	\$ 1,166.99
T3390	29-piece set	\$ 1,023.99

PRODUCT #	DESCRIPTION	PRICE
<b>30" HIGH, 9" WIDTH, 2" STROKE SIZE</b>		
T3410	39-piece set	\$ 850.99
T3420	29-piece set	\$ 738.99
<b>30" HIGH, 12" WIDTH, 3" STROKE SIZE</b>		
T3440	39-piece set	\$ 1,094.99
T3450	29-piece set	\$ 958.99
<b>30" HIGH, 16" WIDTH, 4" STROKE SIZE</b>		
T3470	39-piece set	\$ 1,401.99
T3480	29-piece set	\$ 1,233.99
<b>36" HIGH, 9" WIDTH, 2" STROKE SIZE</b>		
T3500	39-piece set	\$ 983.99
T3510	29-piece set	\$ 860.99
<b>36" HIGH, 12" WIDTH, 3" STROKE SIZE</b>		
T3530	39-piece set	\$ 1,276.99
T3540	29-piece set	\$ 1,140.99
<b>36" HIGH, 16" WIDTH, 4" STROKE SIZE</b>		
T3560	39-piece set	\$ 1,636.99
T3570	29-piece set	\$ 1,436.99
<b>42" HIGH, 12" WIDTH, 3" STROKE SIZE</b>		
T3590	39-piece set	\$ 1,519.99
T3600	29-piece set	\$ 1,331.99
<b>42" HIGH, 16" WIDTH, 4" STROKE SIZE</b>		
T3620	39-piece set	\$ 1,950.99
T3630	29-piece set	\$ 1,713.99
<b>48" HIGH, 12" WIDTH, 3" STROKE SIZE</b>		
T3650	39-piece set	\$ 1,690.99
T3660	29-piece set	\$ 1,481.99
<b>48" HIGH, 16" WIDTH, 4" STROKE SIZE</b>		
T3680	39-piece set	\$ 2,171.99
T3690	29-piece set	\$ 1,897.99



## NUMBER STENCIL SETS

- The 18-piece set consists of: 00, 11, 22, 33, 44, 55, 6, 7, 8, 9, 2-end pieces
- The 12-piece set consists of: 0, 1, 2, 3, 4, 5, 6, 7, 8, 9, 2-end pieces
- The number sets are interlocking and may be used in combination with letters (only up to 42", 48" and up do not interlock)

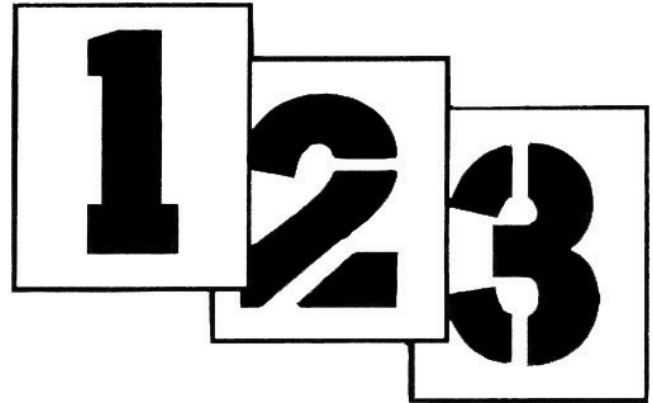

PRODUCT #	DESCRIPTION	PRICE
<b>4" HIGH, 2 1/2" WIDTH, 5/8" STROKE SIZE</b>		
T3930	18-piece set	\$ 70.99
T3940	12-piece set	\$ 54.99
<b>5" HIGH, 3 1/4" WIDTH, 3/4" STROKE SIZE</b>		
T3960	18-piece set	\$ 86.99
T3970	12-piece set	\$ 66.99
<b>6" HIGH, 3 3/4" WIDTH, 1" STROKE SIZE</b>		
T3990	18-piece set	\$ 102.99
T4000	12-piece set	\$ 81.99
<b>8" HIGH, 5" WIDTH, 1 1/4" STROKE SIZE</b>		
T4020	18-piece set	\$ 167.99
T4030	12-piece set	\$ 117.99
<b>10" HIGH, 6" WIDTH, 1 5/8" STROKE SIZE</b>		
T4050	18-piece set	\$ 178.99
T4060	12-piece set	\$ 138.99
<b>12" HIGH, 9" WIDTH, 2" STROKE SIZE</b>		
T4080	18-piece set	\$ 209.99
T4090	12-piece set	\$ 160.99
<b>15" HIGH, 9" WIDTH, 2" STROKE SIZE</b>		
T4110	18-piece set	\$ 255.99
T4120	12-piece set	\$ 183.99
<b>18" HIGH, 9" WIDTH, 2" STROKE SIZE</b>		
T4140	18-piece set	\$ 299.99
T4150	12-piece set	\$ 206.99
<b>24" HIGH, 9" WIDTH, 2" STROKE SIZE</b>		
T4170	18-piece set	\$ 358.99
T4180	12-piece set	\$ 254.99
<b>24" HIGH, 12" WIDTH, 3" STROKE SIZE</b>		
T4200	18-piece set	\$ 425.99
T4210	12-piece set	\$ 303.99
<b>24" HIGH, 16" WIDTH, 4" STROKE SIZE</b>		
T4230	18-piece set	\$ 515.99
T4240	12-piece set	\$ 316.99

PRODUCT #	DESCRIPTION	PRICE
<b>30" HIGH, 9" WIDTH, 2" STROKE SIZE</b>		
T4260	18-piece set	\$ 427.99
T4270	12-piece set	\$ 304.99
<b>30" HIGH, 12" WIDTH, 3" STROKE SIZE</b>		
T4290	18-piece	\$ 482.99
T4300	12-piece	\$ 343.99
<b>30" HIGH, 16" WIDTH, 4" STROKE SIZE</b>		
T4320	18-piece set	\$ 615.99
T4330	12-piece set	\$ 439.99
<b>36" HIGH, 9" WIDTH, 2" STROKE SIZE</b>		
T4350	18-piece set	\$ 499.99
T4360	12-piece set	\$ 353.99
<b>36" HIGH, 12" WIDTH, 3" STROKE SIZE</b>		
T4380	18-piece set	\$ 559.99
T4390	12-piece set	\$ 397.99
<b>36" HIGH, 16" WIDTH, 4" STROKE SIZE</b>		
T4410	18-piece set	\$ 714.99
T4420	12-piece set	\$ 508.99
<b>42" HIGH, 12" WIDTH, 3" STROKE SIZE</b>		
T4440	18-piece set	\$ 665.99
T4450	12-piece set	\$ 474.99
<b>42" HIGH, 16" WIDTH, 4" STROKE SIZE</b>		
T4470	18-piece set	\$ 853.99
T4480	12-piece set	\$ 611.99
<b>48" HIGH, 12" WIDTH, 3" STROKE SIZE</b>		
T4500	18-piece set	\$ 734.99
T4510	12-piece set	\$ 531.99
<b>48" HIGH, 16" WIDTH, 4" STROKE SIZE</b>		
T4530	18-piece set	\$ 980.99
T4540	12-piece set	\$ 678.99

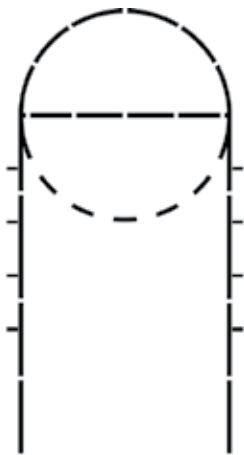

**BASKETBALL COURT KIT**  
12' X 25'

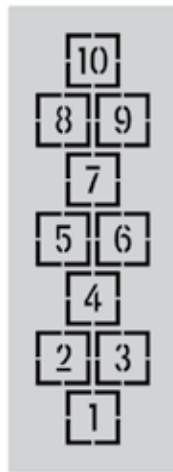

**HOPSCOTCH KITS**  
7'6" X 24"    108" X 40"

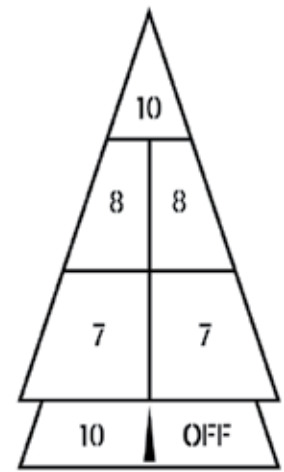
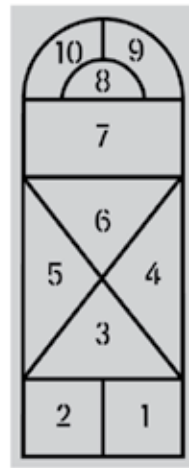

**SHUFFLEBOARD KIT**  
10' X 6' 3 PC.



## PLAYGROUND STENCILS

PRODUCT #	DESCRIPTION	PRICE
T2505	Basketball Court Kit - Key Only 6-pc	\$ 538.99
T2515	Basketball Court Kit - 19'; 3 Point Arc 5-pc	\$ 612.99
T2525	Hopscotch Kit 7' 6" x 24"	\$ 147.99
T2535	Hopscotch Kit 108" x 40"	\$ 195.99
T2555	U.S. Map Kit 19' x 30' - 2" Wide Segmented Lines	\$ 1,963.99

*All sport stencils on this page are 60 mils thick.  
100 mil stencils are also available, with pricing upon request.*



## SHUFFLEBOARD STENCILS

Made to Official National Standard.

- 10' x 6' [3 pieces]

PRODUCT #	DESCRIPTION	PRICE
T3010	Shuffle Board Marking Kit	\$ 458.99



## RUNNING TRACK STENCILS

Running Track Marking Kit includes:

- Roman style numbers 1 thru 8, 36" h x 24" w
- Start, Hurdle, Exchange, Acceleration

PRODUCT #	DESCRIPTION	PRICE
T3000	Running Track Marking Kit	\$ 541.99

# **SportMaster**<sup>®</sup>

**SPORT SURFACES**



**INTRODUCING  
THE  
COLORPLUS  
FUSION  
SYSTEM**

Derived from the original ColorPlus Pigment Dispersions, Fusion combines an equal blend of two standard colors to create an exciting new expanded catalog of colors.

To see the full expanded FUSION color chart, visit [www.sportmaster.net/colorplusfusion](http://www.sportmaster.net/colorplusfusion)

**TOURNAMENT-QUALITY SPORT SURFACING AND REPAIR PRODUCTS**

**SPORT SURFACING**



# SportMaster®

SPORT SURFACES



## COLORPLUS™ SYSTEM

A 100% ACRYLIC, SPORT SURFACING SYSTEM FOR TENNIS, BASKETBALL, AND MULTIPURPOSE COURT SURFACES

**IDEAL FOR APPLICATION ON ASPHALT, CONCRETE AND EXISTING SPORT SURFACES**

### HOW THE SYSTEM WORKS

The ColorPlus System consists of a 100% acrylic Neutral Concentrate (available with or without sand) and the ColorPlus Pigment Dispersion. What is truly remarkable about the ColorPlus System is the fact that only 2 gallons of ColorPlus pigment are needed to colorize an entire 30 gallon keg of Neutral Concentrate.

### EASE OF MIXING

ColorPlus is a highly concentrated pigment dispersion that disperses readily in Neutral Concentrate. Our proprietary technology enables ColorPlus to disperse completely with minimal mixing.

COLORPLUS SYSTEM
Thickness: Approx. 35-40 mils
1 Coat - Acrylic Resurfacer
2 Coats of Color

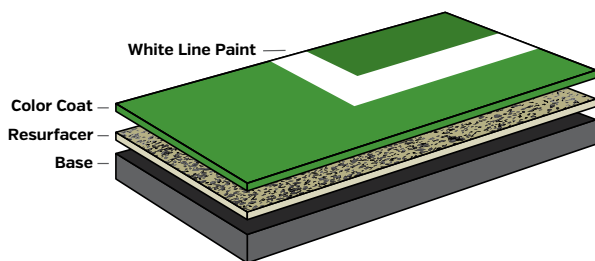

## COLORPLUS™ PIGMENT DISPERSION

A HIGHLY CONCENTRATED PIGMENT DISPERSION

Designed to disperse readily and completely in Neutral Concentrate.



PRODUCT #	DESCRIPTION	WEIGHT	PRICE
C1374G	Forest Green, 1 - Gallon Pail	17 lbs.	\$ 72.99
C1372G	Light Green, 1 - Gallon Pail	17 lbs.	\$ 72.99
C1373G	Dark Green, 1 - Gallon Pail	17 lbs.	\$ 72.99
C1378G	Beige, 1 - Gallon Pail	17 lbs.	\$ 60.99
C1370G	Red, 1 - Gallon Pail	17 lbs.	\$ 60.99
C1386G	Maroon, 1 - Gallon Pail	17 lbs.	\$ 60.99
C1388G	Tournament Purple, 1 - Gallon Pail	17 lbs.	\$ 170.99
C1380G	Gray, 1 - Gallon Pail	17 lbs.	\$ 60.99
C1384G	Blue, 1 - Gallon Pail	17 lbs.	\$ 60.99
C1385G	Light Blue, 1 - Gallon Pail	17 lbs.	\$ 60.99
C1399G	Dove Gray, 1 - Gallon Pail	17 lbs.	\$ 60.99
C1383G	Ice Blue, 1 - Gallon Pail	17 lbs.	\$ 60.99
C1389G	Sandstone, 1 - Gallon Pail	17 lbs.	\$ 72.99
C1379G	Orange, 1 - Gallon Pail	17 lbs.	\$ 136.99
C1390G	Yellow, 1 - Gallon Pail	17 lbs.	\$ 73.99
C1392G	Brite Red, 1 - Gallon Pail	17 lbs.	\$ 291.99
C1660G	Black Dispersion, 1 - Gallon Pail	17 lbs.	\$ 20.99

**COLORPLUS FUSION**

For more than 100 additional color choices, check out ColorPlus Fusion here:  
[www.sportmaster.net/colorplusfusion](http://www.sportmaster.net/colorplusfusion)

MAROON	GRAY	LIGHT BLUE	ICE BLUE LEED CREDIT *SRI=62	ORANGE	FOREST GREEN
TOURNAMENT PURPLE	BLUE	DOVE GRAY LEED CREDIT *SRI=33	SANDSTONE LEED CREDIT *SRI=46	YELLOW	LIGHT GREEN LEED CREDIT *SRI=31

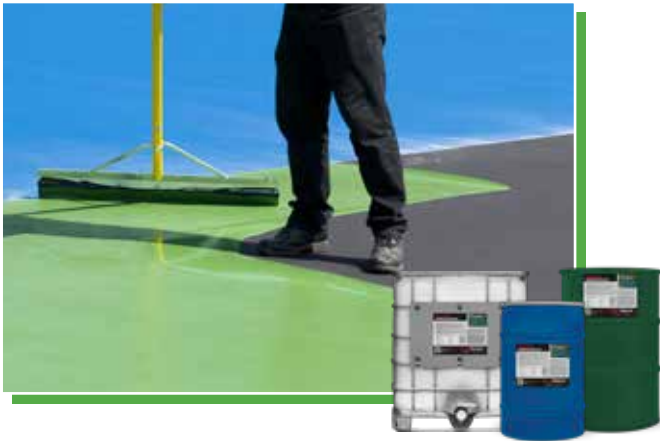

## NEUTRAL CONCENTRATE™

### PREMIUM 100% ACRYLIC EMULSION

Designed for maximum performance and weather resistance. Neutral Concentrate is available with or without sand. Neutral Concentrate can also be used as an acrylic resurfacer filler coat.

PRODUCT #	DESCRIPTION	COVERAGE	WEIGHT	PRICE
C1360K	30 - Gallon Keg	5400 sq. ft.	305 lbs.	\$ 376.99
C1360D	55 - Gallon Drum	9900 sq. ft.	570 lbs.	\$ 585.99
C1360T	275 - Gallon Tote	49500 sq. ft.	2,875 lbs.	\$ 2,944.99
C1360B	Bulk	-	-	- quoted -

**MIXING PROCEDURES:**

*For use as a color coat:*

Neutral Concentrate.....55 gallons  
 Water.....28-33 gallons  
 ColorPlus Pigment Dispersion.....4 gallons  
 Sand [80-100 mesh].....400 lbs.

*For use as an acrylic resurfacer:*

Neutral Concentrate.....55 gallons  
 Water.....30-33 gallons  
 Sand [50-60 mesh].....up to 600 lbs.

**MATERIAL REQUIREMENTS [coverage - 180 sf/gal]:**

*For use as a color coat:*  
 .05 to .07 gallon per square yard per coat

*For use as an acrylic resurfacer:*

.07 to .09 gallon per square yard per coat



Can also be used as an acrylic resurfacer filler coat



## NEUTRAL CONCENTRATE™ WITH SAND

### PREMIUM 100% ACRYLIC EMULSION WITH SAND

Can also be used as an acrylic resurfacer filler coat

PRODUCT #	DESCRIPTION	COVERAGE	WEIGHT	PRICE
C1365K	30 - Gallon Keg	3750 sq. ft.	390 lbs.	\$ 376.99
C1365D	55 - Gallon Drum	6875 sq. ft.	660 lbs.	\$ 585.99
Note: Neutral Concentrate With Sand is not available in 275 - Gallon Totes				
C1365B	Bulk	-	-	- quoted -

**MIXING PROCEDURES:**

*For use as a color coat:*

Neutral Concentrate with Sand.....30 gallons  
 Water.....12 gallons  
 ColorPlus Pigment Dispersion.....2 gallons

**MATERIAL REQUIREMENTS [coverage - 125 sf/gal]:**

*For use as a color coat:*  
 .07 to .09 gallon per square yard per coat

## FLEXIBLE CONCENTRATE

### ELASTOMERIC COLOR COATING BASE TO BE MIXED WITH COLORPLUS PIGMENT DISPERSION FOR LONG-TERM FLEXIBILITY

PRODUCT #	DESCRIPTION	COVERAGE	WEIGHT	PRICE
C1455P	5 - Gallon Pail	900 sq. ft.	48 lbs.	\$ 69.99
C1455K	30 - Gallon Keg	5400 sq. ft.	305 lbs.	\$ 441.99
C1455D	55 - Gallon Drum	9900 sq. ft.	570 lbs.	\$ 700.99



**MIXING PROCEDURES:**

Flexible Concentrate.....55 gallons  
 Water.....28-33 gallons  
 ColorPlus Pigment Dispersion.....4 gallons  
 Sand [80-100 Mesh].....400 lbs.

**MATERIAL REQUIREMENTS [coverage - 180 sf/gal]:**

.05 to .07 gallons per square yard per coat. A minimum of two coats are recommended.

<b>DARK GREEN</b>	<b>BROWN</b> COLORPLUS FUSION	<b>BRITE RED</b>
<b>BEIGE</b>	<b>RED</b> LEED CREDIT *SRI=36	<b>BLACK</b>

**NOTE:** Colors will vary somewhat due to printing limitations. Ask your SealMaster Representative for a color chip card for more accurate representation.

\*Solar Reflectance Index (SRI) is the percentage of solar energy that is reflected by a surface. These specific colors qualify for the LEED [Leadership in Energy and Environmental Design] program under Section SS Credit 7.1: Heat Island Effect: Non-Roof. For more information visit [www.usgbc.org](http://www.usgbc.org) or contact a LEED accredited professional.





# SportMaster®

SPORT SURFACES



## PROCUSHION™ SYSTEM

A 100% ACRYLIC, CUSHIONED SPORT SURFACING SYSTEM FOR TENNIS, BASKETBALL, AND OTHER RECREATIONAL AREAS

**CUSHIONMASTER™ I & II CONTAIN POST-CONSUMER RECYCLED RUBBER**

### Procushion System Uses:

- Tennis, Basketball & Pickleball Courts
- Recreational areas or game courts with tennis shoe traffic
- Walking and jogging trails
- Asphalt, concrete, or existing acrylic surfaces

The ProCushion System adds multiple coats of two unique components between the Acrylic Resurfacer and the colored surface coatings.

### CUSHIONMASTER II

Base layers filled with coarse rubber particles to provide the build, or thickness of the system.

### CUSHIONMASTER I

Top layers fortified with small rubber particles, to fill and smooth out the coarse rubber texture, and prepare to accept the colored surface coatings.

### FLEXIBLE CONCENTRATE

Elastomeric acrylic surfacing layers. Mix with ColorPlus™ Pigment Dispersion to achieve the desired color. Contains proprietary acrylic resin to match the flexibility of the CushionMaster layers.



**FLEXIBLE CONCENTRATE**  
AVAILABLE ON PAGE 103

The SportMaster ProCushion System consists of multiple coats of flexible acrylic layers, filled with rubber granules for shock absorption and cushioned effect, without disrupting ball bounce. SportMaster utilizes elastomeric acrylics which reduce hardening of the coatings. This ensures that you will still feel the cushion after many years and resurfacing cycles.

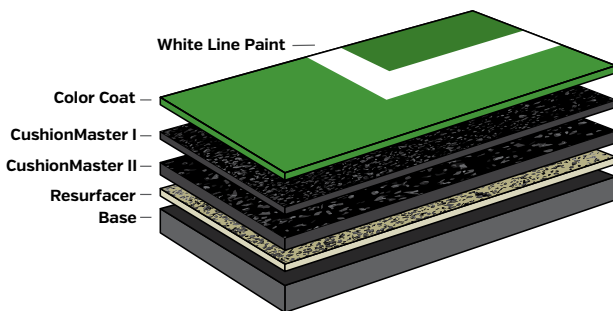

MAROON	GRAY	LIGHT BLUE	ICE BLUE LEED CREDIT *SRI=62	ORANGE	FOREST GREEN
TOURNAMENT PURPLE	BLUE	DOVE GRAY LEED CREDIT *SRI=33	SANDSTONE LEED CREDIT *SRI=46	YELLOW	LIGHT GREEN LEED CREDIT *SRI=31

**There are multiple ProCushion alternative systems to meet your needs:**

PROCUSHION- ECONOMY	PROCUSHION - STANDARD	PROCUSHION - PREMIUM
<b>Thickness: Approx. 75-80 mils</b>	<b>Thickness: Approx. 105-110 mils</b>	<b>Thickness: Approx. 140-145 mils</b>
1 Coat - Acrylic Resurfacer	1 Coat - Acrylic Resurfacer	1 Coat - Acrylic Resurfacer
2 Coats - CushionMaster II	3 Coats - CushionMaster II	5 Coats - CushionMaster II
1 Coat - CushionMaster I	2 Coats - CushionMaster I	2 Coats - CushionMaster I
2 Coats - CushionMaster Color	2 Coats - CushionMaster Color	2 Coats - CushionMaster Color



**CUSHIONMASTER™ I**  
FINE RUBBER

PRODUCT #	DESCRIPTION	COVERAGE	WEIGHT	PRICE
C1450P	5 - Gallon Pail	450 sq. ft.	50 lbs.	\$ 77.99
C1450K	30 - Gallon Keg	2700 sq. ft.	290 lbs.	\$ 474.99
C1450D	55 - Gallon Drum	4950 sq. ft.	550 lbs.	\$ 775.99

**MIXING PROCEDURES:**

CushionMaster I..... 10 gallons  
Water..... 3 gallons

**MATERIAL REQUIREMENTS  
[coverage - 90 sf/gal]:**

.10 gallons per square yard per coat [.20 gallon per square yard for two coats].

**CUSHIONMASTER™ II**  
COARSE RUBBER

PRODUCT #	DESCRIPTION	COVERAGE	WEIGHT	PRICE
C1460P	5 - Gallon Pail	300 sq. ft.	50 lbs.	\$ 77.99
C1460K	30 - Gallon Keg	1800 sq. ft.	290 lbs.	\$ 474.99
C1460D	55 - Gallon Drum	3300 sq. ft.	550 lbs.	\$ 775.99

**MIXING PROCEDURES:**

CushionMaster II..... 10 gallons  
Water..... 3 gallons

**MATERIAL REQUIREMENTS  
[coverage - 60 sf/gal]:**

.15 gallons per square yard per coat [.45 gallon per square yard for three coats].

**DARK GREEN**

**BROWN**  
COLORPLUS FUSION

**BRITE RED**

**BEIGE**

**RED**  
LEED CREDIT \*SRI=36

**BLACK**

**NOTE:** Colors will vary somewhat due to printing limitations. Ask your SealMaster Representative for a color chip card for more accurate representation.

\*Solar Reflectance Index (SRI) is the percentage of solar energy that is reflected by a surface. These specific colors qualify for the LEED [Leadership in Energy and Environmental Design] program under Section SS Credit 7.1: Heat Island Effect: Non-Roof. For more information visit [www.usgbc.org](http://www.usgbc.org) or contact a LEED accredited professional.



# SportMaster®

SPORT SURFACES



## SPORTMASTER® SYSTEM

100% ACRYLIC COLOR COATINGS FOR TENNIS COURTS, RUNNING TRACKS, AND MULTIPURPOSE SPORT SURFACES

**OPTIMUM PERFORMANCE FOR BOTH PLAYER AND SURFACE**

**SportMaster® System Uses:**

- Tennis Courts, Pickleball & Other Racquet Sports
- Basketball Courts
- Playgrounds & Game Courts
- Asphalt or Concrete Recreational Areas
- Multipurpose Courts

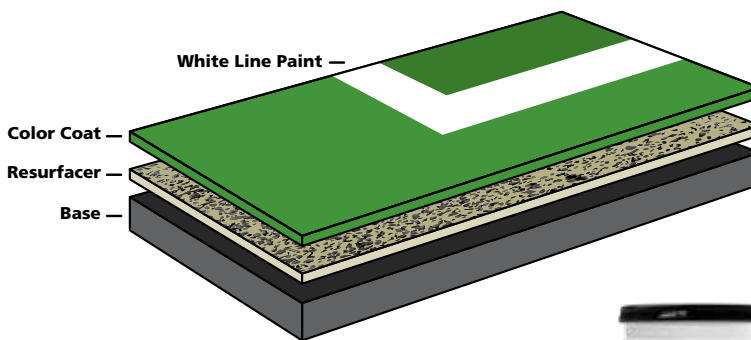

## READY-MIX COLOR

A PREMIUM 100% ACRYLIC EMULSION

Ready-Mix Color is ideal for maintenance crews and do-it-yourselfers. The proper sand and water is already added. Simply stir, pour, and apply by soft rubber squeegee. Available in 8 standard colors. Ready-Mix Color is available in 5-gallon pails. [See page 116 for Sport Squeegee.]

<b>FOREST GREEN</b>	<b>LIGHT GREEN</b> LEED CREDIT *SRI=31
<b>DARK GREEN</b>	<b>BEIGE</b>
<b>BROWN</b> COLORPLUS FUSION	<b>RED</b> LEED CREDIT *SRI=36
<b>MAROON</b>	<b>GRAY</b>
<b>BLUE</b>	

PRODUCT #	DESCRIPTION	COVERAGE	WEIGHT	PRICE
C1230P	Forest Green - 5 gal. Pail	375 sq. ft.	60 lbs.	\$ 69.99
C1250P	Light Green - 5 gal. Pail	375 sq. ft.	60 lbs.	\$ 69.99
C1282P	Dark Green - 5 gal. Pail	375 sq. ft.	60 lbs.	\$ 69.99
C1200P	Beige - 5 gal. Pail	375 sq. ft.	60 lbs.	\$ 69.99
C1270P	Red - 5 gal. Pail	375 sq. ft.	60 lbs.	\$ 68.99
C1260P	Maroon - 5 gal. Pail	375 sq. ft.	60 lbs.	\$ 68.99
C1240P	Gray - 5 gal. Pail	375 sq. ft.	60 lbs.	\$ 68.99
C1210P	Blue - 5 gal. Pail	375 sq. ft.	60 lbs.	\$ 68.99

**NOTE:** Colors will vary somewhat due to printing limitations. Ask your SealMaster Representative for a color chip card for more accurate representation.

\*Solar Reflectance Index [SRI] is the percentage of solar energy that is reflected by a surface. These specific colors qualify for the LEED (Leadership in Energy and Environmental Design) program under Section SS Credit 7.1: Heat Island Effect: Non-Roof. For more information visit [www.usgbc.org](http://www.usgbc.org) or contact a LEED accredited professional.

**MIXING PROCEDURES:**

Use as is. Do not dilute. Simply stir, pour, and apply.

**MATERIAL REQUIREMENTS**

[coverage - 75 sf/gal]:

.12 to .15 gallon of Ready-Mix per square yard per coat. Two coats are recommended.



## COLOR CONCENTRATE

A 100% acrylic emulsion coating designed for on-site mixing with silica sand and water. Ideal for color coating tennis courts, basketball courts, and other pavement surfaces. Two coats minimum are recommended. The sand used for mixing with color concentrate should be an 80-100 mesh, ultra fine sand. Apply by soft rubber squeegee. Available in 8 standard colors. Color Concentrate is available in 5-gallon pails "P", 30-gallon Kegs "K", and 55-gallon drums "D".

PRODUCT #	DESCRIPTION	COVERAGE	WEIGHT	PRICE
C1030P	Forest Green - Pail	900 sq. ft.	48 lbs.	\$ 77.99
C1030K	Forest Green - Keg	5400 sq. ft.	305 lbs.	\$ 492.99
C1030D	Forest Green - Drum	9900 sq. ft.	570 lbs.	\$ 797.99
C1050P	Light Green - Pail	900 sq. ft.	48 lbs.	\$ 77.99
C1050K	Light Green - Keg	5400 sq. ft.	305 lbs.	\$ 492.99
C1050D	Light Green - Drum	9900 sq. ft.	570 lbs.	\$ 797.99
C1082P	Dark Green - Pail	900 sq. ft.	48 lbs.	\$ 77.99
C1082K	Dark Green - Keg	5400 sq. ft.	305 lbs.	\$ 492.99
C1082D	Dark Green - Drum	9900 sq. ft.	570 lbs.	\$ 797.99
C1000P	Beige - Pail	900 sq. ft.	48 lbs.	\$ 77.99
C1000K	Beige - Keg	5400 sq. ft.	305 lbs.	\$ 492.99
C1000D	Beige - Drum	9900 sq. ft.	570 lbs.	\$ 797.99
C1070P	Red - Pail	900 sq. ft.	48 lbs.	\$ 74.99
C1070K	Red - Keg	5400 sq. ft.	305 lbs.	\$ 474.99
C1070D	Red - Drum	9900 sq. ft.	570 lbs.	\$ 768.99
C1060P	Maroon - Pail	900 sq. ft.	48 lbs.	\$ 74.99
C1060K	Maroon - Keg	5400 sq. ft.	305 lbs.	\$ 474.99
C1060D	Maroon - Drum	9900 sq. ft.	570 lbs.	\$ 768.99
C1040P	Gray - Pail	900 sq. ft.	48 lbs.	\$ 74.99
C1040K	Gray - Keg	5400 sq. ft.	305 lbs.	\$ 474.99
C1040D	Gray - Drum	9900 sq. ft.	570 lbs.	\$ 768.99
C1010P	Blue - Pail	900 sq. ft.	48 lbs.	\$ 74.99
C1010K	Blue - Keg	5400 sq. ft.	305 lbs.	\$ 474.99
C1010D	Blue - Drum	9900 sq. ft.	570 lbs.	\$ 768.99

**MIXING PROCEDURES:**

Color Concentrate..... 55 gallons  
 Water.....28-33 gallons  
 Sand (80-100 Mesh).....400 lbs.

**MATERIAL REQUIREMENTS (coverage - 180 sf/gal):**

.05 to .07 gallons per square yard per coat. A minimum of two coats are recommended.

## COLOR CONCENTRATE WITH SAND

Similar to our standard Concentrate but with sand already added. Color Concentrate™ with Sand takes the guesswork out of choosing the right type of sand. Easy to use, just add water and apply by soft rubber squeegee. Available in 8 standard colors. Color Concentrate (with sand) is available in 5-gallon pails "P", 30-gallon Kegs "K", and 55-gallon drums "D".

PRODUCT #	DESCRIPTION	COVERAGE	WEIGHT	PRICE
C1130P	Forest Green - Pail	625 sq. ft.	66 lbs.	\$ 77.99
C1130K	Forest Green - Keg	3750 sq. ft.	390 lbs.	\$ 492.99
C1130D	Forest Green - Drum	6875 sq. ft.	660 lbs.	\$ 797.99
C1150P	Light Green - Pail	625 sq. ft.	66 lbs.	\$ 77.99
C1150K	Light Green - Keg	3750 sq. ft.	390 lbs.	\$ 492.99
C1150D	Light Green - Drum	6875 sq. ft.	660 lbs.	\$ 797.99
C1182P	Dark Green - Pail	625 sq. ft.	66 lbs.	\$ 77.99
C1182K	Dark Green - Keg	3750 sq. ft.	390 lbs.	\$ 492.99
C1182D	Dark Green - Drum	6875 sq. ft.	660 lbs.	\$ 797.99
C1100P	Beige - Pail	625 sq. ft.	66 lbs.	\$ 77.99
C1100K	Beige - Keg	3750 sq. ft.	390 lbs.	\$ 492.99
C1100D	Beige - Drum	6875 sq. ft.	660 lbs.	\$ 797.99
C1170P	Red - Pail	625 sq. ft.	66 lbs.	\$ 74.99
C1170K	Red - Keg	3750 sq. ft.	390 lbs.	\$ 474.99
C1170D	Red - Drum	6875 sq. ft.	660 lbs.	\$ 768.99
C1160P	Maroon - Pail	625 sq. ft.	66 lbs.	\$ 74.99
C1160K	Maroon - Keg	3750 sq. ft.	390 lbs.	\$ 474.99
C1160D	Maroon - Drum	6875 sq. ft.	660 lbs.	\$ 768.99
C1140P	Gray - Pail	625 sq. ft.	66 lbs.	\$ 74.99
C1140K	Gray - Keg	3750 sq. ft.	390 lbs.	\$ 474.99
C1140D	Gray - Drum	6875 sq. ft.	660 lbs.	\$ 768.99
C1110P	Blue - Pail	625 sq. ft.	66 lbs.	\$ 74.99
C1110K	Blue - Keg	3750 sq. ft.	390 lbs.	\$ 474.99
C1110D	Blue - Drum	6875 sq. ft.	660 lbs.	\$ 768.99

**MIXING PROCEDURES:**

Color Concentrate with Sand .....30 gallons  
 Water..... 12 gallons

**MATERIAL REQUIREMENTS (coverage - 125 sf/gal):**

.07 to .09 gallons per square yard per coat. A minimum of two coats are recommended.

DESIGNED TO SMOOTH & LEVEL PAVEMENT PRIOR TO COLOR COATING

Available in 100% acrylic formulations. SportMaster Resurfacers can be used for both coating and patching.

## ACRYLIC RESURFACER

THE ULTIMATE TENNIS COURT RESURFACER

**Acrylic Resurfacer Features:**

- 100% Acrylic
- Available in both black and neutral colors
- Can be used as a coating or patching material
- Also available with sand already added [Acrylic Resurfacer w/ Sand]

PRODUCT #	DESCRIPTION	COVERAGE	WEIGHT	PRICE
C1300P	Black 5 - Gallon Pail	625 sq. ft.	48 lbs.	\$ 65.99
C1300K	Black 30 - Gallon Keg	3,750 sq. ft.	280 lbs.	\$ 409.99
C1300D	Black 55 - Gallon Drum	6,875 sq. ft.	525 lbs.	\$ 649.99
C1300B	Bulk	-	-	-quoted-
C1310P	Neutral 5 - Gallon Pail	625 sq. ft.	48 lbs.	\$ 65.99
C1310K	Neutral 30 - Gallon Keg	3,750 sq. ft.	280 lbs.	\$ 409.99
C1310D	Neutral 55 - Gallon Drum	6,875 sq. ft.	525 lbs.	\$ 649.99
C1310B	Bulk	-	-	-quoted-

**MIXING PROCEDURES:**

Acrylic Resurfacer.....55 gallons  
 Water.....33 gallons  
 Sand [50-60 Mesh].....800 lbs.

**MATERIAL REQUIREMENTS**

[coverage - 125 sf/gal]:  
 .07 to .09 gallon per square yard per coat.



Neutral Resurfacer



Black Resurfacer

## ACRYLIC RESURFACER WITH SAND

PRODUCT #	DESCRIPTION	COVERAGE	WEIGHT	PRICE
C1330P	Black 5 - Gallon Pail	400 sq. ft.	73 lbs.	\$ 65.99
C1330K	Black 30 - Gallon Keg	2,400 sq. ft.	435 lbs.	\$ 409.99
C1330D	Black 55 - Gallon Drum	4,400 sq. ft.	785 lbs.	\$ 649.99

**MIXING PROCEDURES:**

Acrylic Resurfacer with Sand...30 gallons  
 Water.....12 gallons

**MATERIAL REQUIREMENTS**

[coverage - 80 sf/gal]:  
 .11 to .13 gallon per square yard per coat.



## FLEXIBLE ACRYLIC RESURFACER™

**Flexible Acrylic Resurfacer Features:**

- Elastomeric formula for long-term flexibility
- Ideal for crack repair, membrane repairs & cushioned courts
- Neutral color

PRODUCT #	DESCRIPTION	COVERAGE	WEIGHT	PRICE
C1320P	5 - Gallon Pail	625 sq. ft.	48 lbs.	\$ 68.99
C1320K	30 - Gallon Keg	3,750 sq. ft.	280 lbs.	\$ 449.99
C1320D	55 - Gallon Drum	6,875 sq. ft.	525 lbs.	\$ 712.99

**MIXING PROCEDURES:**

Flexible Acrylic Resurfacer.....55 gallons  
 Silica Sand [50-60 Mesh].....500-600 lbs.  
 Water.....33 gallons

**MATERIAL REQUIREMENTS**

[coverage - 125 sf/gal]:  
 .07 to .09 gallon per square yard per coat.



ALL CATALOG PRICES ARE F.O.B. SANDUSKY, OHIO



## ACRYLIC PATCH BINDER

A 100% acrylic liquid binder designed for on-site mixing with sand and cement. Ideal for leveling and repairing low spots and depressions up to 1/2" deep on tennis court and other sport surface pavements.

**NOTE:** Patching Straightedges available on page 116.

PRODUCT #	DESCRIPTION	WEIGHT	PRICE
C1480P	5 - Gallon Pail	47 lbs.	\$ 117.99
C1480K	30 - Gallon Keg	280 lbs.	\$ 723.99
C1480D	55 - Gallon Drum	500 lbs.	\$ 1,232.99

**MIXING PROCEDURES:**

Acrylic Patch Binder..... 3.5 gallons  
 Sand [50-60 Mesh].....100 lbs.  
 Cement.....15-20 lbs.  
 Water.....up to 1/2 gallon if needed

**NOTE:** Thoroughly mix dry sand and cement together first before adding to Acrylic Patch Binder.

**MATERIAL REQUIREMENTS (coverage):**

One gallon will produce enough patch mix (when mixed with sand and cement) to fill .86 square yard (approximately 7.75 square feet) at 1/4" depth.



## CRACKMAGIC™

Premium grade heavy-bodied 100% acrylic elastomeric crack filler. Remains flexible at temperatures below zero. Available in neutral, green and red. Packaged four 1-gallon pails to a box or sold individually.

PRODUCT #	DESCRIPTION	WEIGHT	PRICE
C1590G	Neutral 1 - Gallon Pail	10 lbs.	\$ 53.99
C1570G	Green 1 - Gallon Pail	10 lbs.	\$ 53.99
C1580G	Red 1 - Gallon Pail	10 lbs.	\$ 53.99

**MIXING PROCEDURES:**

Use as is. Do not dilute.

**MATERIAL REQUIREMENTS (coverage):**

Typically, one gallon will fill approximately 75-150 feet of cracks depending on depth and width of crack.



## ACRYLIC CRACK PATCH

A 100% acrylic trowel grade crack filler. Fortified with sand for filling cracks up to 1" wide on tennis courts and other sport surface pavements. Available in red, green, blue or neutral. Packaged in four 1-gallon pails to a box or sold individually.

PRODUCT #	DESCRIPTION	WEIGHT	PRICE
C1520G	Neutral 1 - Gallon Pail	17 lbs.	\$ 22.99
C1500G	Green 1 - Gallon Pail	17 lbs.	\$ 22.99
C1510G	Red 1 - Gallon Pail	17 lbs.	\$ 22.99
C1515G	Blue 1 - Gallon Pail	17 lbs.	\$ 22.99

**MIXING PROCEDURES:**

Use as is. Do not dilute.

**MATERIAL REQUIREMENTS (coverage):**

Typically, one gallon will fill approximately 75-150 feet of cracks depending on depth and width of crack.



## COURTFLEX™ CRACK SEALANT

A 100% acrylic elastomeric crack sealant designed for filling cracks up to 1/2" wide. Flexible down to -10°F. Available in red, green or neutral. Packaged six jugs to a box or sold individually.

PRODUCT #	DESCRIPTION	WEIGHT	PRICE
C1560G	Neutral 1 - Gallon Jug	10 lbs.	\$ 31.99
C1540G	Green 1 - Gallon Jug	10 lbs.	\$ 31.99
C1550G	Red 1 - Gallon Jug	10 lbs.	\$ 31.99

**MIXING PROCEDURES:**

Use as is. Do not dilute.

**MATERIAL REQUIREMENTS (coverage):**

Typically, one gallon will fill approximately 150-200 feet of cracks depending on depth and width of crack.



## CLEAR CRACK SEALANT

Clear drying acrylic crack sealant for small cracks on sport surfaces. Keep cracks sealed on sport surfaces without seeing unsightly repairs.

PRODUCT #	DESCRIPTION	WEIGHT	PRICE
C1530G	1 - Gallon Pail	10 lbs.	\$ 57.99

**MIXING PROCEDURES:**

Use as is. Do not dilute.

**MATERIAL REQUIREMENTS (coverage):**

Typically, one gallon will fill approximately 150-200 feet of cracks depending on depth and width of crack.

NEW PRODUCT

## WHITE LINE PAINT

A 100% acrylic water-based line paint highly pigmented for one coat coverage. Packaged in easy-to-use 1-gallon jugs with pour spouts, and 5-gallon pails. Available without or with sand [textured].

**NOTE:** See Line Taping Machine on page 115.

PRODUCT #	DESCRIPTION	WEIGHT	PRICE
C1600G	1 - Gallon Jug	12 lbs.	\$ 36.99
C1600P	5 - Gallon Pail	60 lbs.	\$ 141.99
C1620G	Textured 1 - Gallon Jug	13 lbs.	\$ 36.99
C1620P	Textured 5 - Gallon Pail	65 lbs.	\$ 141.99



### MIXING PROCEDURES:

Use as is. Do not dilute.

### MATERIAL REQUIREMENTS (coverage):

500-600 feet of 2" line per gallon.

## STRIPE RITE™

FOR SHARP LINES! A 100% acrylic, clear-drying emulsion primer that is applied prior to T/C line paint to fill the minor voids between the masking tape and court surface. Assures crisp, razor-sharp lines.

PRODUCT #	DESCRIPTION	WEIGHT	PRICE
C1610G	1 - Gallon Jug	10 lbs.	\$ 23.99
C1610P	5 - Gallon Pail	47 lbs.	\$ 85.99

### MIXING PROCEDURES:

Use as is. Do not dilute.

### MATERIAL REQUIREMENTS (coverage):

500-600 feet of 2" line per gallon.



## ACRYLIC ADHESION PROMOTER

100% acrylic emulsion primer designed to promote the adhesion of repair products and coatings. Apply by spray, roller, or brush. Ready to use.

PRODUCT #	DESCRIPTION	COVERAGE	WEIGHT	PRICE
C1650P	5 - Gallon Pail	1,250 sq. ft.	46 lbs.	\$ 68.99
C1650K	30 - Gallon Keg	7,500 sq. ft.	270 lbs.	\$ 420.99
C1650D	55 - Gallon Drum	13,750 sq. ft.	510 lbs.	\$ 678.99

### MIXING PROCEDURES:

Use as is. Do not dilute.

### MATERIAL REQUIREMENTS (coverage):

200-300 square feet per gallon.



## SPORTWAX™ CLEAR COAT

Clear drying, 100% acrylic top coat for tennis courts, basketball courts, and more. Extends the life of surface coatings. Apply by squeegee, lambswool applicator, or spray. SportWax Clear Coat is a ready-to-use product.

PRODUCT #	DESCRIPTION	COVERAGE	WEIGHT	PRICE
C1850P	5 - Gallon Pail	1250 sq. ft.	46 lbs.	\$ 86.99
C1850K	30 - Gallon Keg	7500 sq. ft.	270 lbs.	\$ 528.99
C1850D	55 - Gallon Drum	13750 sq. ft.	510 lbs.	\$ 860.99

### MIXING PROCEDURES:

Use as is. Do not dilute.

### MATERIAL REQUIREMENTS (coverage):

200-300 feet per gallon.



# SportMaster®

SPORT SURFACES



## SKATEMASTER™ SYSTEM

A 100% ACRYLIC, SPECIALIZED SURFACING SYSTEM FOR INLINE ROLLER HOCKEY, SKATEBOARDING AND MORE

### HIGH PERFORMANCE SURFACE COATING

#### SkateMaster System Uses:

- Rollerblading, skateboarding, and other roller sports
- Shuffleboard courts
- Playgrounds, game courts, basketball, etc.
- Multipurpose or heavy use areas

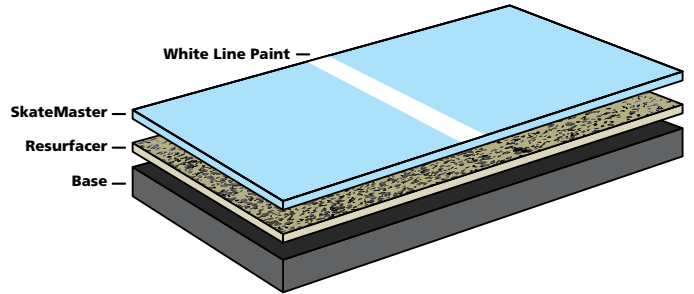

The SkateMaster System is comprised of the following products:

#### ACRYLIC RESURFACER - (Neutral)™

(1-2 coats) to fill voids in pavement and provide texture to ensure thorough coverage of the SkateMaster Coating.

#### SKATEMASTER™

(2-3 coats) SkateMaster comes in a neutral base, and is mixed with ColorPlus Pigment Dispersion to achieve any of the standard ColorPlus colors.

SKATEMASTER
Thickness: Approx. 40-45 mils
1 Coat - Acrylic Resurfacer
2 Coats - SkateMaster

## NEUTRAL SKATEMASTER™

PRODUCT #	DESCRIPTION	COVERAGE	WEIGHT	PRICE
C1800K	30 - Gallon Keg	4500 sq.ft.	305 lbs.	\$ 538.99
C1800D	55 - Gallon Drum	8250 sq. ft.	520 lbs.	\$ 884.99

#### MIXING PROCEDURES:

Neutral SkateMaster™ .....55 gallons  
 ColorPlus™ Pigment Dispersion..... 4 gallons

**NOTE:** Up to 8 lbs. per gallon of sand (80-100 mesh) can be added to SkateMaster™ for a customized multipurpose surface.

#### MATERIAL REQUIREMENTS (coverage - 150 sf/gal):

.06 to .08 gallons per square yard per coat. (.12 to .16 gallons per square yard for two coats).

MAROON	GRAY	LIGHT BLUE	ICE BLUE LEED CREDIT *SRI=62	ORANGE	BRITE RED
TOURNAMENT PURPLE	BLUE	DOVE GRAY LEED CREDIT *SRI=33	SANDSTONE LEED CREDIT *SRI=46	YELLOW	BLACK
FOREST GREEN	DARK GREEN	BROWN COLORPLUS FUSION			
LIGHT GREEN LEED CREDIT *SRI=31	BEIGE	RED LEED CREDIT *SRI=36			

**NOTE:** Colors will vary somewhat due to printing limitations. Ask your SealMaster Representative for a color chip card for more accurate representation.

\*Solar Reflectance Index (SRI) is the percentage of solar energy that is reflected by a surface. These specific colors qualify for the LEED [Leadership in Energy and Environmental Design] program under Section SS Credit 7.1: Heat Island Effect: Non-Roof. For more information visit [www.usgbc.org](http://www.usgbc.org) or contact a LEED accredited professional.





NEW IN 2019

## TRACKMASTER PRO™

FULL-DEPTH RUBBERIZED RUNNING TRACK SURFACING SYSTEM

AVAILABLE IN BLACK OR MULTIPLE COLORS

Multi-resin running track surfaces for college, high school, and other competition & recreational running tracks. Provides excellent footing and shock absorption, along with pleasing aesthetics.

For more information visit [www.sportmaster.net/trackmasterpro](http://www.sportmaster.net/trackmasterpro)



## SportMaster® SPORT SURFACES

## TRACKMASTER PLUS™

A 100% ACRYLIC COATING FOR RUNNING TRACK & OTHER RECREATIONAL SURFACES



AVAILABLE IN SEVERAL COLORS

Premium quality, 100% acrylic emulsion fortified with rubber particles designed for coating asphalt and latex/ rubber running track surfaces. TrackMaster Plus is available in attractive colors using the SportMaster ColorPlus™ System. TrackMaster Plus contains rubber granules. Squeegee, brush or spray application.

### TrackMaster Plus Product Uses:

- Running Tracks
- Walking paths and jogging trails
- Coatings for rubberized asphalt tracks
- Asphalt, concrete, or existing acrylic surfaces

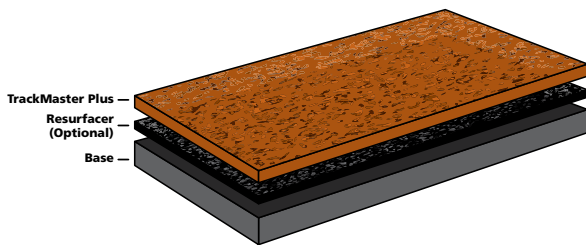

PRODUCT #	DESCRIPTION	COVERAGE	WEIGHT	PRICE
C1740K	Neutral 30 - Gallon Keg	1500 sq. ft.	290 lbs.	\$ 375.99
C1740D	Neutral 55 - Gallon Drum	2750 sq. ft.	550 lbs.	\$ 574.99
C1709K	Red 30 - Gallon Keg	1500 sq. ft.	290 lbs.	\$ 483.99
C1709D	Red 55 - Gallon Drum	2750 sq. ft.	550 lbs.	\$ 760.99

### TRACKMASTER PLUS

Thickness: Approx. 50-55 mils

1 Coat - Acrylic Resurfacer

2 Coats - TrackMaster Plus

### MIXING PROCEDURES:

Neutral TrackMaster Plus.....55 gallons  
 Water.....13-14 gallons  
 ColorPlus Pigment Dispersion [page 102]..... 4 gallons

### MATERIAL REQUIREMENTS [coverage - 50 sf/gal]:

Approximately .15 to .20 gallon per square yard per coat depending on surface porosity.



MAROON	GRAY	LIGHT BLUE	ICE BLUE LEED CREDIT *SRI=62	ORANGE	FOREST GREEN
TOURNAMENT PURPLE	BLUE	DOVE GRAY LEED CREDIT *SRI=33	SANDSTONE LEED CREDIT *SRI=46	YELLOW	LIGHT GREEN LEED CREDIT *SRI=31



## TRACKMASTER™

A polymer modified asphalt emulsion fortified with rubber particles designed for coating asphalt running tracks. Beautifies tracks and provides superior protection against oxidation, ravelling, and moisture penetration. Available in black only.

PRODUCT #	DESCRIPTION	COVERAGE	WEIGHT	PRICE
C1700K	30 - Gallon Keg	1500 sq. ft.	300 lbs.	\$ 279.99
C1700D	55 - Gallon Drum	2750 sq. ft.	575 lbs.	\$ 403.99
C1700B	Bulk	-	-	- quoted -

**MIXING PROCEDURES:**

TrackMaster.....55 gallons  
 Water.....15 - 17 gallons  
 Mix and apply with soft rubber squeegee or spray.

**MATERIAL REQUIREMENTS (coverage - 50 sf/gal):**

Approximately .15 to .20 gallon per square yard per coat depending on surface porosity.



## LANE ONE™

A 100% acrylic, trowel-grade patching material fortified with sand and rubber. Ideal for repairing running lanes and field event runways and pads. Also used for filling cracks up to 1" wide. Lane One is Black, but can be coated with TrackMaster Plus to match surface color of track area.

PRODUCT #	DESCRIPTION	WEIGHT	PRICE
C1750P	5 - Gallon Pail	51 lbs.	\$ 61.99
C1750K	30 - Gallon Keg	305 lbs.	\$ 379.99
C1750D	55 - Gallon Drum	545 lbs.	\$ 598.99

**MIXING PROCEDURES:**

Use as is. Do not dilute. Apply with soft rubber squeegee.

**MATERIAL REQUIREMENTS (coverage):**

Approximately 1 gallon per square yard at 1/8" depth. Ultimate coverage will be dependent upon depth of repair.

## TRACKFLEX™ CRACK SEALANT



Acrylic elastomeric pourable crack sealant designed for sealing cracks up to 1/2" wide in asphalt or latex/rubber track surfaces. TrackFlex is black, but can be coated with TrackMaster Plus to match surface color of track area.

PRODUCT #	DESCRIPTION	WEIGHT	PRICE
C1760G	1 - Gallon Jug	10 lbs.	\$ 32.99
C1760P	5 - Gallon Pail	47 lbs.	\$ 127.99

**MIXING PROCEDURES:**

Use as is. Do not dilute. Smooth flush with rubber squeegee.

**MATERIAL REQUIREMENTS (coverage):**

Typically, one gallon will fill approximately 75-150 feet of cracks depending on depth and width of crack.

## BLACK DISPERSION

For tinting running track latex and neutral coatings. Mix 1 gallon of Black Dispersion per 55 gallons of latex or neutral coatings.



PRODUCT #	DESCRIPTION	WEIGHT	PRICE
C1660G	1 - Gallon Pail	11 lbs.	\$ 20.99
C1660P	5 - Gallon Pail	53 lbs.	\$ 83.99
C1660D	55 - Gallon Drum	590 lbs.	\$ 870.99

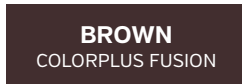

**NOTE:** Colors will vary somewhat due to printing limitations. Ask your SealMaster Representative for a color chip card for more accurate representation.

\*Solar Reflectance Index (SRI) is the percentage of solar energy that is reflected by a surface. These specific colors qualify for the LEED [Leadership in Energy and Environmental Design] program under Section SS Credit 7.1: Heat Island Effect: Non-Roof. For more information visit [www.usgbc.org](http://www.usgbc.org) or contact a LEED accredited professional.



## TENNIS NETS

**TOURNAMENT TAPERED** - 3mm braided body, double [2] layer vinyl headband, double top 6 mesh body, fiberglass dowels, 42' x 3 1/4' [42" high at posts - tapers to 36]

**TOURNAMENT DH** - DH-3mm braided body, 42' x 3 1/4', double [2] layer vinyl headband, coated cable, dowels: also available in 33' and 36' lengths for single courts.

PRODUCT #	DESCRIPTION	WEIGHT	PRICE
T5350	Tournament Tapered	24 lbs.	\$ 195.99
T5355	Tournament DH	19 lbs.	\$ 150.99



## NET ACCESSORIES

PRODUCT #	DESCRIPTION	WEIGHT	PRICE
T5400	Deluxe Adjustable Center Strap - 2" Polyester White	1 lb.	\$ 13.99
T5410	Center Pipe Anchor - 1.9" O.D. Galvanized Steel	2 lbs.	\$ 14.99

## POST SLEEVE T-PLUGS



PRODUCT #	DESCRIPTION	WEIGHT	PRICE
T5390	Steel T-Plugs - Round 3" O.D. [set of 2] - Black	6 lbs.	\$ 66.99/set
T5395	Steel T-Plugs - Square 3" [set of 2] - Black	6 lbs.	\$ 66.99/set
T5470	Steel T-Plugs - Round 2 7/8" [set of 2] - Black	6 lbs.	\$ 66.99/set



Premier Net Posts available in Round or Square design.



E-Z Tennis Post

Post Sleeves

## NET POSTS AND SLEEVES

PRODUCT #	DESCRIPTION	WEIGHT	PRICE
<b>Premier Net Posts - Round</b> Round internal wind net posts - 3" O.D.			
T5360G	Net Posts - Green	46 lbs.	\$ 384.99
T5360B	Net Posts - Black	46 lbs.	\$ 384.99
T5365	Galvanized Round Net Post Sleeves	10 lbs.	\$ 60.99
<b>Premier Net Posts - Square</b> Square internal wind net posts - 3" sq.			
T5370G	Net Posts - Green	54 lbs.	\$ 405.99
T5370B	Net Posts - Black	54 lbs.	\$ 405.99
T5375	Galvanized Square Net Post Sleeves	35 lbs.	\$ 108.99
<b>E-Z Tennis Posts - Round</b> Round external wind net posts - 2 7/8" O.D.			
T5380G	Net Posts - Green	62 lbs.	\$ 299.99
T5380B	Net Posts - Black	62 lbs.	\$ 299.99
T5385	PVC Round Net Post Sleeves	5 lbs.	\$ 40.99



## PICKLEBALL / KIDS TENNIS

PRODUCT #	DESCRIPTION	WEIGHT	PRICE
<b>Premier Net Posts - Round [36" above ground] - 3" O.D.</b>			
T5475	Premier 36" Green	42 lbs.	\$ 384.99
T5480	Premier 36" Black	42 lbs.	\$ 384.99
T5365	Galvanized Round Net Post Sleeves	10 lbs.	\$ 60.99
T5485	Pickleball / Kids Net	14 lbs.	\$ 142.99

ALL CATALOG PRICES ARE F.O.B. SANDUSKY, OHIO

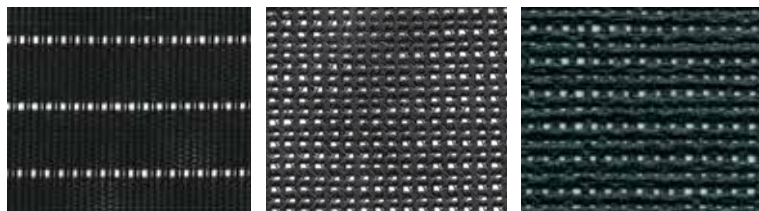

POLY-PRO

VCP VINYL

DOURASCREEN

Digital printing and logos available at additional cost [VCP only]

## WINDSCREENS

PRODUCT #	DESCRIPTION	WEIGHT	PRICE
<b>Poly-Pro / Open Mesh</b> Available in 6' and 9' heights [100% Polypropylene]			
T5435G	6' Dark Green	.06 lbs./sq. ft.	\$.93/sq. ft.
T5440G	9' Dark Green - Includes Center Tab*	.06 lbs./sq. ft.	\$.98/sq. ft.
T5435B	6' Black	.06 lbs./sq. ft.	\$.93/sq. ft.
T5440B	9' Black - Includes Center Tab*	.06 lbs./sq. ft.	\$.98/sq. ft.
<b>VCP Vinyl / Open Mesh</b> Available in 6' and 9' heights [50% Vinyl, 50% Polyester]			
T5425G	6' Dark Green	.06 lbs./sq. ft.	\$.88/sq. ft.
T5430G	9' Dark Green - Includes Center Tab*	.06 lbs./sq. ft.	\$.93/sq. ft.
T5425B	6' Black	.06 lbs./sq. ft.	\$.88/sq. ft.
T5430B	9' Black - Includes Center Tab*	.06 lbs./sq. ft.	\$.93/sq. ft.
<b>Dourascreen / Open Mesh</b> Available in 6' and 9' heights [22% high tenacity fiber, 78% foam PVC]			
T5415G	6' Dark Green	.08 lbs./sq. ft.	\$1.29/sq. ft.
T5420G	9' Dark Green - Includes Center Tab*	.08 lbs./sq. ft.	\$1.34/sq. ft.
T5415B	6' Black	.08 lbs./sq. ft.	\$1.29/sq. ft.
T5420B	9' Black - Includes Center Tab*	.08 lbs./sq. ft.	\$1.34/sq. ft.

\* Includes center tab with grommets for attaching center to fence

All windscreens grommeted every 18" on top, bottom, and middle [horizontal connections] and every 12" on the sides [vertical connections]

•• Custom labor charges may apply



## WINDSCREEN ACCESSORIES

PRODUCT #	DESCRIPTION	PRICE
T5445	AVR Air Vent Reinforced	\$ 11.99 ea.
T5450	Die Cut Air Vent [VCP only]	\$ 5.99 ea.
T5455	C-Snaps 3" Plastic - Box of 100	\$ 42.99
T5460	Tie Wraps case of 100 - 7" 50 lbs. break-strength	\$ 11.99
T5462	Tie Wraps case of 100 - 8" 120 lbs. break-strength	\$ 20.99
T5465	Braided Lacing Cord Reel - 600 ft. black [fastens windscreens]	\$ 102.99



## PORTABLE NET SYSTEMS

PRODUCT #	DESCRIPTION	WEIGHT	PRICE
T5490	Pickleball - 8 & Under Portable Net [22' L x 36" H]	95 lbs.	\$ 544.99
T5496	Pickleball Portable Net [22' L x 36" H]	24 lbs.	\$ 208.99



## LINE TAPING MACHINE

A must for striping tennis courts, basketball courts, and other surfaces where precision markings are required. Lays tape for lines up to 4" wide. Comes with guides for 18mm, 24mm, and 48mm tape [metric equivalents for 3/4", 1" & 2"]. Imperial tape guides are also available.

PRODUCT #	DESCRIPTION	WEIGHT	PRICE
T7600	Line Taping Machine	16 lbs.	\$ 817.99
T7610	Pole Extension Kit [For 3-point lines and extra large circles]	13 lbs.	\$ 244.99



## MASKING TAPE

PRODUCT #	DESCRIPTION	WEIGHT	PRICE
T1560	1-inch Green Single Roll	2 lbs.	\$ 11.99
T1570	1-inch Green Case of 36 Rolls	16 lbs.	\$ 394.99
T1580	2-inch Single Roll	1 lb.	\$ 5.99
T1590	2-inch Case of 24 Rolls	16 lbs.	\$ 108.99



## MYSTICWASHER

IDEAL FOR FLAT SURFACE AND VERTICAL CLEANING!

### MysticWasher Features:

- Available in 24" and 30" cleaning widths
- Housing is aircraft aluminum and powder-coated steel
- Pneumatic, adjustable front casters
- Siphon tube chemical injection system
- Professional spray wand with five quick-connect tips

PRODUCT #	DESCRIPTION	WEIGHT
T6011	MW24 24" Cleaning Path	200 lbs.
T6012	MW30 30" Cleaning Path	200 lbs.

\* Call for pricing



## PATCHING STRAIGHTEDGE

The smoothest patches ever in just one pass of the straightedge. Ideal for patching and filling low spots in tennis courts, parking lots, and driveways. Makes patching a one-man operation. Lightweight yet durable metal construction. Available in 4, 6, 8, and 10 ft. widths. Includes wood handle.

PRODUCT #	DESCRIPTION	WEIGHT	PRICE
T1500	4-foot with Handle	12 lbs.	\$ 132.99
T1510	6-foot with Handle	15 lbs.	\$ 135.99
T1520	8-foot with Handle	20 lbs.	\$ 143.99
T1530	10-foot with Handle	25 lbs.	\$ 148.99
T1490	Straightedge Handle	2 lbs.	\$ 14.99

\* NOTE: The 10-foot straight edge must ship common carrier. Others can ship UPS.



## LIGHTWEIGHT ALUMINUM SPORT SQUEEGEE

THE ULTIMATE SQUEEGEE

Ideal for Tennis Court Color Coatings as well as pavement sealers. Features soft, tapered rubber blade for superior results on both sport courts as well as asphalt pavement.

PRODUCT #	DESCRIPTION	WEIGHT	PRICE
T1277	24" Sport Squeegee Complete	4 lbs.	\$ 79.99
T1272	36" Sport Squeegee Complete	6 lbs.	\$ 91.99
T1292	48" Sport Squeegee Complete	8 lbs.	\$ 109.99
T1311	60" Lightweight Squeegee Complete	9 lbs.	\$ 104.99

### A) RUBBER REFILLS:

T1278	24" Sport Rubber Blade Refill	3 lbs.	\$ 22.99
T1326	36" Sport Rubber Blade Refill	3 lbs.	\$ 30.99
T1327	48" Sport Rubber Blade Refill	3 lbs.	\$ 40.99
T1324	60" Lightweight Squeegee Rubber Refill	4 lbs.	\$ 39.99

### B) RUBBER REFILLS:

T1281	36" Rubber Refill	3 lbs.	\$ 25.99
T1301	48" Rubber Refill	3 lbs.	\$ 32.99
T1321	60" Rubber Refill	4 lbs.	\$ 39.99



**DRILL PADDLE MIXER**

Designed for mixing 55 gallon drums.

PRODUCT #	DESCRIPTION	WEIGHT	PRICE
T9000	30" height with 8.5" x 5" paddle	3 lbs.	\$ 50.99
T9001	48" height with 8.5" x 5" paddle	4 lbs.	\$ 62.99



**COURT DRY ROLLER**

PRODUCT #	DESCRIPTION	WEIGHT	PRICE
T5505	36" Court Dry Roller	6 lbs.	\$ 69.99



**BASKETBALL GOAL ADJUSTABLE SYSTEM**

- Features:**
- J-Bolt Anchor System
  - Pressure Flex™ Goal
  - 6'-10' Adjustable Rim Height
  - Backboard and Pole Padding



PRODUCT #	DESCRIPTION	WEIGHT	PRICE
<b>Adjustable Basketball Systems - 6" sq. Pole (Glass backboards)</b>			
T5301	Adjustable Basketball System - 4' Ext., 42" x 5' Backboard	650 lbs.	\$ 1,844.99
T5302	Adjustable Basketball System - 4' Ext., 42" x 6' Backboard	680 lbs.	\$ 1,925.99
T5303	Adjustable Basketball System - 5' Ext., 42" x 6' Backboard	690 lbs.	\$ 2,081.99



**BASKETBALL GOAL GOOSENECK SYSTEM**

- Features:**
- Zinc Plated Pole and Hardware
  - Heavy-duty backboard support braces
  - Standard in-ground installation (Direct Bury)

PRODUCT #	DESCRIPTION	WEIGHT	PRICE
<b>Fan Shaped Steel Backboard - Designed for 10' rim height</b>			
T5308	Gooseneck Basketball Goal - 3.5" O.D. Pole, 3' Ext.	278 lbs.	\$ 1,042.99
T5309	Gooseneck Basketball Goal - 4.5" O.D. Pole, 4' Ext.	315 lbs.	\$ 1,233.99



Trailer Mounted Tanks



Skid Mounted Tanks

## COLOR COATING MIXING TANKS

ULTIMATE MACHINES FOR MIXING & PUMPING  
TENNIS COURT SURFACING MATERIALS

AVAILABLE IN SKID OR TRAILER MOUNT

### Color Coating Mixing Tank Features:

- Available in dual 200 or dual 300 gallon tank design
- Air-driven dual diaphragm 2-inch pump
- 200-feet of 1-inch hose and wand
- Full-sweep, super heavy duty agitation - hydraulically driven

Unique Dual  
Tank Designs

PRODUCT #	DESCRIPTION	WEIGHT
E2100	Dual 200 Skid Unit	4,000 lbs.
E2120	Dual 300 Skid Unit	4,200 lbs.
E2140	Dual 200 Trailer Unit - Two (6,000 lb.) axles with electric brakes and lights	6,000 lbs.
E2160	Dual 300 Trailer Unit - Two (8,000 lbs.) axles with electric brakes and lights	5,840 lbs.

\* Call for pricing

ALL CATALOG PRICES ARE F.O.B. SANDUSKY, OHIO

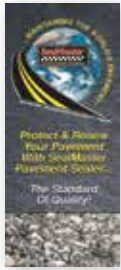

### SM-11 MAILER

A 3-fold, single page mailer with detachable return card that is ideal for direct mail campaigns.

PRODUCT #	DESCRIPTION	PRICE
A1220	SM-11, 4" x 9"	\$ 51.99/100



### SM-14 DOORKNOB HANGER

Explains the benefits of sealcoating.

PRODUCT #	DESCRIPTION	PRICE
A1230	SM-14, 4.5" x 10"	\$ 34.99/100



### SM-21 HOT POUR CRACK FILLER BROCHURE

Describes our four grades of CrackMaster hot pour crack fillers and the benefits of each.

PRODUCT #	DESCRIPTION	PRICE
A1260	SM-21, 8.5" x 11"	\$ 26.99/100



### SM-180 COLD POUR CRACK FILLER BROCHURE

A 4-page brochure describing the benefits of using cold-applied crack fillers.

PRODUCT #	DESCRIPTION	PRICE
A1275	SM-180, 8.5" x 11"	\$ 43.99/100



### SM-38 COLORPAVE® BROCHURE

1-page brochure, explains the benefits of ColorPave.

PRODUCT #	DESCRIPTION	PRICE
A1217	SM-38, 8.5" x 11"	\$ 18.99/100



### SM-202 PROPERTY MANAGER BROCHURE

A 3-fold, single page mailer for pavement maintenance solutions for today's property manager.

PRODUCT #	DESCRIPTION	PRICE
A1236	SM-202, 4.5" x 8.5"	\$ 33.99/100

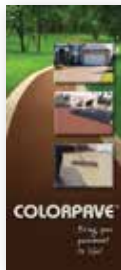

### SM-113 COLORPAVE® HD TRI-FOLD

Tri-fold with actual color chips attached.

PRODUCT #	DESCRIPTION	PRICE
A1414	SM-113, 8.5" x 3.75"	\$ 2.80 ea.



### CM-2 TENNIS COURT COLOR CHART

A 4-page brochure containing textured color chips for tennis coatings and in-line skate coatings. Contains description and benefits.

PRODUCT #	DESCRIPTION	PRICE
A1410	CM-2, 8.5" x 11"	\$ 2.95 ea.





**SM-220 LIQUID ROAD™ BROCHURE**

4-page brochure, explains the benefits of Liquid Road.

PRODUCT #	DESCRIPTION	PRICE
A1221	SM-220, 7.5" x 9.5"	\$ 33.99/100



**SM-221 MASTERSEAL® BROCHURE**

4-page brochure, explains the benefits of MasterSeal.

PRODUCT #	DESCRIPTION	PRICE
A1213	SM-221, 7.5" x 9.5"	\$ 33.99/100



**SM-232 PMCTS BROCHURE**

4-page brochure, explains the benefits of Polymer Modified Coal Tar Sealer.

PRODUCT #	DESCRIPTION	PRICE
A1233	SM-232, 7.5" x 9.5"	\$ 33.99/100



**SM-228 OPTIPAVE® BROCHURE**

4-page brochure, explains the benefits of OptiPave.

PRODUCT #	DESCRIPTION	PRICE
A1237	SM-228, 7.5" x 9.5"	\$ 33.99/100



**SM-223 ASPEN™ AC BROCHURE**

4-page brochure, explains the benefits of Aspen AC.

PRODUCT #	DESCRIPTION	PRICE
A1218	SM-223, 7.5" x 9.5"	\$ 33.99/100



**SM-226 COAL TAR BROCHURE**

4-page brochure, explains the benefits of Coal Tar Sealer.

PRODUCT #	DESCRIPTION	PRICE
A1214	SM-226, 7.5" x 9.5"	\$ 33.99/100

ALL CATALOG PRICES ARE F.O.B. SANDUSKY, OHIO



**SM-222 PMM BROCHURE**

4-page brochure, explains the benefits of Polymer Modified Masterseal.

PRODUCT #	DESCRIPTION	PRICE
A1235	SM-222, 7.5" x 9.5"	\$ 33.99/100



**SM-19 SEALMASTER® PROPOSAL FOLDER**

Full color high gloss proposal folder for making professional sales presentations.

PRODUCT #	DESCRIPTION	PRICE
A1270	SM-19, 9" x 12"	\$ 3.00 ea.



**SM-230 SEALMASTER® ADVANTAGE BROCHURE**

4-page brochure, explains the benefits of SealMaster and our products.

PRODUCT #	DESCRIPTION	PRICE
A1212	SM-230, 8.5" x11"	\$ 39.99/100



**SM-33 MASTERSEAL® SEALER TRI-FOLD**

Describes the benefits of MasterSeal. Includes actual sample with sand.

PRODUCT #	DESCRIPTION	PRICE
A1228	SM-33, 8.5" x 3.75"	\$ 61.99/100



**SM-29 LIQUID ROAD™ TRI-FOLD**

Describes the benefits of Liquid Road. Includes actual sample with sand.

PRODUCT #	DESCRIPTION	PRICE
A1226	SM-29, 8.5" x 3.75"	\$ 61.99/100



**SM-147 PMCTS TRI-FOLD**

Describes the benefits of Polymer-Modified Coal Tar Sealer. Includes actual sample with sand.

PRODUCT #	DESCRIPTION	PRICE
A1232	SM-147, 8.5" x 3.75"	\$ 61.99/100



**SM-149 PMM TRI-FOLD**

Describes the benefits of Polymer Modified MasterSeal. Includes actual sample with sand.

PRODUCT #	DESCRIPTION	PRICE
A1234	SM-149, 8.5" x 3.75"	\$ 61.99/100



**SM-31 COAL TAR SEALER TRI-FOLD**

Describes the benefits of SealMaster Coal Tar Sealer. Includes actual sample with sand.

PRODUCT #	DESCRIPTION	PRICE
A1227	SM-31, 8.5" x 3.75"	\$ 61.99/100

All clothing is embroidered and made of high quality materials. IMPORTANT: Please state size and color when ordering clothing items. NOTE: Add \$2.00 to all XXL-XXXL sizes. NOTE: Styles and designs are subject to change.



### SEALMASTER® & SPORTMASTER® POLO-STYLE SHIRT

- SealMaster colors: white, black, and red  
Size: S, M, L, XL, [XXL-XXXL - add \$2]
- SportMaster colors: green, white  
Size: L, XL, [XXL-XXXL - add \$2]

When ordering, please list size designation after the product number. [i.e. A1778XL]

PRODUCT #	DESCRIPTION	PRICE
A1770	SealMaster Polo - White	\$ 40.99
A1776	SealMaster Polo - Red	\$ 40.99
A1778	SealMaster Polo - Black	\$ 40.99
A1790	SportMaster Polo - White	\$ 40.99
A1793	SportMaster Polo - Green	\$ 40.99



### SEALMASTER® & SPORTMASTER® T-SHIRT WITH FRONT POCKET

- SealMaster color: gray  
Size: S, M, L, XL, [XXL-XXXL - add \$2]
- SportMaster color: white  
Size: L, XL

When ordering, please list size designation after the product number. [i.e. A1778XL]

PRODUCT #	DESCRIPTION	PRICE
A1800	SealMaster T-Shirt	\$ 22.99
A1810	SportMaster T-Shirt	\$ 22.99



### SEALMASTER® SAFETY YELLOW T-SHIRT & GLOVES

- Size: S, M, L, XL, [XXL-XXXL - add \$2]

When ordering, please list size designation after the product number. [i.e. A1778XL]

PRODUCT #	DESCRIPTION	PRICE
A1775	Safety Yellow T-Shirt	\$ 26.99
A1777	Safety Yellow Gloves	\$ 12.99



### SEALMASTER® & SPORTMASTER® JACKETS

- Color: Black  
Size: M, L, XL, [XXL - add \$2]

When ordering, please list size designation after the product number. [i.e. A1778XL]

PRODUCT #	DESCRIPTION	PRICE
A1925	SportMaster - Heavy Fleece Lined Coat	\$ 89.99
A1920	SealMaster - Heavy Fleece Lined Coat	\$ 89.99
A1926	SealMaster - Wind Half-Zip Jacket	\$ 64.99



### SEALMASTER® CHILD ROMPER

- SealMaster colors: Pink or Blue  
Size: 18-24 mos.

PRODUCT #	DESCRIPTION	PRICE
A1860	Pink SealMaster Romper	\$ 57.99
A1862	Blue SealMaster Romper	\$ 57.99



**SEALMASTER® & SPORTMASTER® COFFEE CUPS**

PRODUCT #	DESCRIPTION	PRICE
A1710	SealMaster Coffee Cup	\$ 9.99
A1720	SportMaster Coffee Cup	\$ 9.99



**SEALMASTER® & SPORTMASTER® BUMPER STICKERS**

PRODUCT #	DESCRIPTION	PRICE
A2595	SealMaster Bumper Sticker	\$ 4.99
A2596	SportMaster Bumper Sticker	\$ 5.99



**SEALMASTER® HATS**

PRODUCT #	DESCRIPTION	PRICE
A1730B	SealMaster Black Hat	\$ 11.99
A1735	SealMaster Camo Hat	\$ 10.99

**SPORTMASTER® HAT**

PRODUCT #	DESCRIPTION	PRICE
A1740	SportMaster White Hat	\$ 19.99



**SEALMASTER® & SPORTMASTER® LOGO PENS**

PRODUCT #	DESCRIPTION	PRICE
A1750	SealMaster Pen	\$ 1.75
A1760	SportMaster Pen	\$ 1.75



**DIE-CAST SEALMASTER® NHRA TOP FUEL DRAGSTER**

- 1:24 Scale
- Limited Edition
- Total Length Assembled: 16 1/2"

PRODUCT #	DESCRIPTION	PRICE
A6325	Die-Cast SealMaster Dragster	\$ 69.99





# No.18 **SealMaster**<sup>®</sup> HONDA

Coyne / Vasser / Sullivan Racing  
Honda / Dallara / Firestone



Driver  
**SEBASTIEN  
BOURDAIS**

**AGE:** 40  
**HOMETOWN:** Le Mans, France  
**RESIDENCE:** St. Petersburg, FL

IndyCar  
Career Statistics

<b>SEASONS:</b> 14	<b>PODIUM:</b> 56
<b>CAREER STARTS:</b> 188	<b>TOP-FIVE:</b> 76
<b>WINS:</b> 37	<b>TOP 10:</b> 111
<b>SERIES CHAMPIONSHIPS:</b> 4	<b>POLES:</b> 34
	<b>LAPS LED:</b> 2,639



# 2019 SCHEDULE

- S** **MARCH 10**  
Streets of St. Petersburg
- S** **MARCH 24**  
Circuit of The Americas
- S** **APRIL 7**  
Barber Motorsports Park
- S** **APRIL 14**  
Streets of Long Beach
- S** **MAY 11**  
Indianapolis Motor Speedway  
Road Course
- S** **MAY 26**  
The 103rd Indianapolis 500
- S** **JUNE 1-2**  
Streets of Detroit

- S** **JUNE 8**  
Texas Motor Speedway
- S** **JUNE 23**  
Road America
- S** **JULY 14**  
Streets of Toronto
- S** **JULY 20**  
Iowa Speedway
- S** **JULY 28**  
Mid-Ohio Sports Car Course
- S** **AUGUST 18**  
Pocono Raceway
- S** **AUGUST 24**  
Gateway Motorsports Park
- S** **SEPTEMBER 1**  
Portland International Raceway
- S** **SEPTEMBER 22**  
WeatherTech Raceway Laguna Seca

**S** Oval      **S** Street/Road Course



**DALE COYNE  
RACING**  
WITH **VASSER SULLIVAN**  
— OFFICIAL PARTNER —

## CAR SPECS

**WEIGHT:**  
1,590 lb. - 1,620 lb.  
venue dependent

**ENGINE DISPLACEMENT:**  
2.2 L [134 cu in.] DOHC V6

**GEARBOX:**  
6-speed paddle shift gearbox

**POWER OUTPUT:**  
550-750 + 60 hp [push-to-  
pass] venue dependent

**ASPIRATION:**  
Twin-turbocharged

**WHEELBASE:**  
117.5-121.5 in. [adjustable]



# YOUR ONE-STOP SOURCE

**Pavement Products & Equipment**

**ALSO AVAILABLE**

- Equipment Rental
- Sport Surfacing Products

**sealmaster.net | 800-395-7325**



**PAVEMENT SEALERS**



**REPAIR PRODUCTS**



**TRAFFIC PAINTS**



**EQUIPMENT/TOOLS**



**SealMaster®**  
  
 Pavement Products & Equipment

The One-Stop Source for  
 all your Pavement Needs

**CALL (800) 395-7325 - LOCATIONS NATIONWIDE**

**[www.sealmaster.net](http://www.sealmaster.net)**

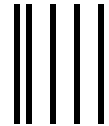

NO POSTAGE  
 NECESSARY  
 IF MAILED  
 IN THE  
 UNITED STATES

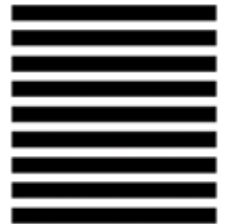

**BUSINESS REPLY MAIL**

FIRST CLASS MAIL PERMIT NO. 28000 SANDUSKY, OH

POSTAGE WILL BE PAID BY ADDRESSEE

**SealMaster®**  
 PO Box 2277  
 Sandusky, OH 44871-9824



**CREDIT TERMS & CONDITIONS:**

Credit terms are net 30 days [unless otherwise indicated]. Any amount remaining unpaid after such date will incur a service charge of 1.5% [monthly] on the unpaid balance, until paid in full, plus any and all collection costs and attorney fees incurred to collect unpaid balances.

**RETURNED MATERIAL POLICY:**

We will normally accept returned material under the following conditions:

1. Prior written authorization from SealMaster® is obtained.
2. A copy of the invoice is furnished.
3. The material is returned within 60 days from date of invoice.
4. The material is in new resaleable condition.
5. The material is normal stock for us [not a special or custom order].
6. A 15% restocking fee plus applicable freight will be imposed on all returns. Returned material, like all other purchased material, should be paid for when due.

**SECURITY:**

The buyer hereby grants SealMaster® a purchase money security interest in the equipment/materials described in the invoices. To secure the debtor's payment for equipment/materials it shall remain the seller's until payment in full is made by the buyer. If the buyer defaults in such payment, the seller may declare all sums payable by the buyer hereunder immediately due payable and the seller may repossess the equipment/materials and or exercise all the rights and remedies of a secured party under the Uniform Commercial Code.





# ACCOUNT APPLICATION

*It's easy to open your SealMaster® Account*

Enjoy the convenience of purchasing SealMaster® pavement products with 30 day credit terms. Simply fill out this form, detach, and mail. [Subject to credit approval].

TRADE NAME / LEGAL BUSINESS NAME: \_\_\_\_\_

ADDRESS: \_\_\_\_\_

CITY: \_\_\_\_\_ STATE: \_\_\_\_\_ ZIP: \_\_\_\_\_ COUNTRY: \_\_\_\_\_

CONTACT: \_\_\_\_\_ PHONE: \_\_\_\_\_ FAX: \_\_\_\_\_

E-MAIL: \_\_\_\_\_

\_\_\_\_\_ CORPORATION \_\_\_\_\_ PARTNERSHIP \_\_\_\_\_ PROPRIETORSHIP

SOCIAL SECURITY #: \_\_\_\_\_

TYPE/NATURE OF BUSINESS: \_\_\_\_\_ ESTABLISHED IN: \_\_\_\_\_

IN ABOVE ADDRESS SINCE: \_\_\_\_\_

NUMBER OF EMPLOYEES: \_\_\_\_\_ CREDIT LIMIT DESIRED: \_\_\_\_\_

FED ID#: \_\_\_\_\_

### THE PRINCIPAL OFFICERS - PARTNERS ARE:

NAME	HOME ADDRESS/PHONE	TITLE
_____	_____	_____
_____	_____	_____

### TRADE REFERENCES:

NAME: \_\_\_\_\_

NAME: \_\_\_\_\_

ADDRESS: \_\_\_\_\_

ADDRESS: \_\_\_\_\_

CITY/STATE/ZIP: \_\_\_\_\_

CITY/STATE/ZIP: \_\_\_\_\_

PHONE: \_\_\_\_\_

PHONE: \_\_\_\_\_

FAX: \_\_\_\_\_

FAX: \_\_\_\_\_

CONTACT: \_\_\_\_\_

CONTACT: \_\_\_\_\_

### BANK REFERENCE:

NAME OF BANK: \_\_\_\_\_

CONTACT: \_\_\_\_\_

PHONE #: \_\_\_\_\_

ACCOUNT #: \_\_\_\_\_

SAVINGS: \_\_\_\_\_

CHECKING: \_\_\_\_\_

### FINANCIAL RESPONSIBILITY:

In consideration of the extension of credit to your company, the undersigned agree[s] to be personally responsible for such indebtedness, as may be incurred from time to time, together with collection costs and reasonable attorney's fees. I [we] hereby certify the information provided SealMaster® is true and correct to the best of my [our] knowledge and authorize the release of information on this account to SealMaster® for the purpose of extending credit.

SIGNATURE: \_\_\_\_\_

PRINT: \_\_\_\_\_

DATE: \_\_\_\_\_

SIGNATURE: \_\_\_\_\_

PRINT: \_\_\_\_\_

DATE: \_\_\_\_\_